



# 瓷介电容器

# Ceramic Capacitors



## □用途 (Application)

该产品主要用于彩电、计算机显示器、复印机、节能灯等的电源电路，行输出电路等部分。

Using for H-out and supply circuits of colour TV and monitor、copy machine、inverter lighting .

## □规格型号 (Specification Type)

编码 code	品名 (CODE NO.)	Dmax (mm)	Tmax (mm)	F (mm)	d (mm)
	CT81-1KV-06*-2B4-101K-*	6.5	4.0	5.0/7.5/10	0.52
	CT81-1KV-06*-2B4-151K-*	6.5	4.0	5.0/7.5/10	0.52
	CT81-1KV-06*-2B4-221K-*	6.5	4.0	5.0/7.5/10	0.52
	CT81-1KV-06*-2B4-331K-*	6.5	4.0	5.0/7.5/10	0.52
	CT81-1KV-06*-2B4-391K-*	6.5	4.0	5.0/7.5/10	0.52
	CT81-1KV-06*-2B4-471K-*	6.5	4.0	5.0/7.5/10	0.52
	CT81-1KV-06*-2B4-561K-*	6.5	4.0	5.0/7.5/10	0.52
	CT81-1KV-06*-2B4-681K-*	6.5	4.0	5.0/7.5/10	0.52
	CT81-1KV-06*-2B4-821K-*	6.5	4.0	5.0/7.5/10	0.52
	CT81-1KV-06*-2B4-102K-*	6.5	4.0	5.0/7.5/10	0.52
	CT81-1KV-06*-2B4-122K-*	6.5	4.0	5.0/7.5/10	0.52
	CT81-1KV-08*-2B4-152K-*	8.5	4.0	5.0/7.5/10	0.52
	CT81-1KV-08*-2B4-182K-*	8.5	4.0	5.0/7.5/10	0.52
	CT81-1KV-08*-2B4-222K-*	8.5	4.0	5.0/7.5/10	0.52
	CT81-1KV-12*-2B4-272K-*	12.5	4.0	5.0/7.5/10	0.52
	CT81-1KV-12*-2B4-332K-*	12.5	4.0	5.0/7.5/10	0.52
	CT81-1KV-12*-2B4-392K-*	12.5	4.0	5.0/7.5/10	0.52
	CT81-1KV-12*-2B4-472K-*	12.5	4.0	5.0/7.5/10	0.52
	CT81-1KV-14*-2B4-682K-*	14.5	4.0	5.0/7.5/10	0.52
	CT81-1KV-16*-2B4-103K-*	16.0	4.0	5.0/7.5/10	0.52
	CT81-1KV-06*-2R4-101K-*	6.5	4.0	5.0/7.5/10	0.52
	CT81-1KV-06*-2R4-151K-*	6.5	4.0	5.0/7.5/10	0.52
	CT81-1KV-06*-2R4-221K-*	6.5	4.0	5.0/7.5/10	0.52
	CT81-1KV-06*-2R4-331K-*	6.5	4.0	5.0/7.5/10	0.52
	CT81-1KV-08*-2R4-471K-*	8.5	4.0	5.0/7.5/10	0.52
	CT81-1KV-08*-2R4-561K-*	8.5	4.0	5.0/7.5/10	0.52
	CT81-1KV-08*-2R4-681K-*	8.5	4.0	5.0/7.5/10	0.52
	CT81-1KV-10*-2R4-821K-*	10.0	4.0	5.0/7.5/10	0.52
	CT81-1KV-10*-2R4-102K-*	10.0	4.0	5.0/7.5/10	0.52
	CT81-1KV-12*-2R4-152K-*	12.5	4.0	5.0/7.5/10	0.52
	CT81-1KV-12*-2R4-222K-*	12.5	4.0	5.0/7.5/10	0.52
	CT81-1KV-06*-2E4-222M-*	6.5	4.0	5.0/7.5/10	0.52
	CT81-1KV-08*-2E4-472M-*	8.5	4.0	5.0/7.5/10	0.52
	CT81-1KV-10*-2E4-682M-*	10.0	4.0	5.0/7.5/10	0.52
	CT81-1KV-12*-2E4-103M-*	12.5	4.0	5.0/7.5/10	0.52

编码 code	品名 (CODE NO.)	D <sub>max</sub> (mm)	T <sub>max</sub> (mm)	F (mm)	d (mm)
	CT81-1KV-06*-HR-101K-*	6.5	4.0	5.0/7.5/10	0.52
	CT81-1KV-06*-HR-151K-*	6.5	4.0	5.0/7.5/10	0.52
	CT81-1KV-06*-HR-221K-*	6.5	4.0	5.0/7.5/10	0.52
	CT81-1KV-06*-HR-331K-*	6.5	4.0	5.0/7.5/10	0.52
	CT81-1KV-08*-HR-471K-*	8.5	4.0	5.0/7.5/10	0.52
	CT81-1KV-08*-HR-561K-*	8.5	4.0	5.0/7.5/10	0.52
	CT81-1KV-08*-HR-681K-*	8.5	4.0	5.0/7.5/10	0.52
	CT81-1KV-10*-HR-821K-*	10.0	4.0	5.0/7.5/10	0.52
	CT81-1KV-10*-HR-102K-*	10.0	4.0	5.0/7.5/10	0.52
	CT81-1KV-12*-HR-152K-*	12.5	4.0	5.0/7.5/10	0.52
	CT81-1KV-12*-HR-222K-*	12.5	4.0	5.0/7.5/10	0.52
	CT81-1KV-06*-2F4-222M-*	6.5	4.0	5.0/7.5/10	0.52
	CT81-1KV-08*-2F4-472M-*	8.5	4.0	5.0/7.5/10	0.52
	CT81-1KV-10*-2F4-103M-*	10.0	4.0	5.0/7.5/10	0.52
	CT81-1KV-12*-2F4-203Z-*	12.5	4.0	7.5/10	0.52
	CT81-1KV-12*-2F4-223Z-*	12.5	4.0	7.5/10	0.52
	CT81-2KV-06*-2B4-101K-*	6.5	5.0	5.0/7.5/10	0.52
	CT81-2KV-06*-2B4-151K-*	6.5	5.0	5.0/7.5/10	0.52
	CT81-2KV-06*-2B4-221K-*	6.5	5.0	5.0/7.5/10	0.52
	CT81-2KV-06*-2B4-331K-*	6.5	5.0	5.0/7.5/10	0.52
	CT81-2KV-06*-2B4-391K-*	6.5	5.0	5.0/7.5/10	0.52
	CT81-2KV-06*-2B4-471K-*	6.5	5.0	5.0/7.5/10	0.52
	CT81-2KV-06*-2B4-561K-*	6.5	5.0	5.0/7.5/10	0.52
	CT81-2KV-08*-2B4-681K-*	8.5	5.0	5.0/7.5/10	0.52
	CT81-2KV-08*-2B4-821K-*	8.5	5.0	5.0/7.5/10	0.52
	CT81-2KV-08*-2B4-102K-*	8.5	5.0	5.0/7.5/10	0.52
	CT81-2KV-09*-2B4-122K-*	9.5	5.0	5.0/7.5/10	0.52
	CT81-2KV-09*-2B4-152K-*	9.5	5.0	5.0/7.5/10	0.52
	CT81-2KV-09*-2B4-182K-*	9.5	5.0	5.0/7.5/10	0.52
	CT81-2KV-11*-2B4-222K-*	11.0	5.0	5.0/7.5/10	0.52
	CT81-2KV-12*-2B4-272K-*	12.5	5.0	7.5/10	0.52
	CT81-2KV-12*-2B4-332K-*	12.5	5.0	7.5/10	0.52
	CT81-2KV-14*-2B4-392K-*	14.5	5.0	7.5/10	0.52
	CT81-2KV-16*-2B4-472K-*	16.0	5.0	7.5/10	0.52
	CT81-2KV-06*-2R4-101K-*	6.5	5.0	5.0/7.5/10	0.52
	CT81-2KV-06*-2R4-151K-*	6.5	5.0	5.0/7.5/10	0.52
	CT81-2KV-06*-2R4-221K-*	6.5	5.0	5.0/7.5/10	0.52
	CT81-2KV-08*-2R4-331K-*	8.5	5.0	5.0/7.5/10	0.52
	CT81-2KV-08*-2R4-391K-*	8.5	5.0	5.0/7.5/10	0.52
	CT81-2KV-08*-2R4-471K-*	8.5	5.0	5.0/7.5/10	0.52
	CT81-2KV-09*-2R4-561K-*	9.5	5.0	5.0/7.5/10	0.52





编码 code	品名 (CODE NO.)	D <sub>max</sub> (mm)	T <sub>max</sub> (mm)	F (mm)	d (mm)
	CT81-1KV-06*-2B4-101K-*T*	6.5	4.0	5.0	0.52
	CT81-1KV-06*-2B4-151K-*T*	6.5	4.0	5.0	0.52
	CT81-1KV-06*-2B4-221K-*T*	6.5	4.0	5.0	0.52
	CT81-1KV-06*-2B4-331K-*T*	6.5	4.0	5.0	0.52
	CT81-1KV-06*-2B4-391K-*T*	6.5	4.0	5.0	0.52
	CT81-1KV-06*-2B4-471K-*T*	6.5	4.0	5.0	0.52
	CT81-1KV-06*-2B4-561K-*T*	6.5	4.0	5.0	0.52
	CT81-1KV-06*-2B4-681K-*T*	6.5	4.0	5.0	0.52
	CT81-1KV-06*-2B4-821K-*T*	6.5	4.0	5.0	0.52
	CT81-1KV-06*-2B4-102K-*T*	6.5	4.0	5.0	0.52
	CT81-1KV-06*-2B4-122K-*T*	6.5	4.0	5.0	0.52
	CT81-1KV-08*-2B4-152K-*T*	8.5	4.0	5.0	0.52
	CT81-1KV-08*-2B4-182K-*T*	8.5	4.0	5.0	0.52
	CT81-1KV-08*-2B4-222K-*T*	8.5	4.0	5.0	0.52
	CT81-1KV-12*-2B4-272K-*T*	12.5	4.0	5.0	0.52
	CT81-1KV-12*-2B4-332K-*T*	12.5	4.0	5.0	0.52
	CT81-1KV-12*-2B4-392K-*T*	12.5	4.0	5.0	0.52
	CT81-1KV-12*-2B4-472K-*T*	12.5	4.0	5.0	0.52
	CT81-1KV-06*-2E4-222M-*T*	6.5	4.0	5.0	0.52
	CT81-1KV-08*-2E4-472M-*T*	8.5	4.0	5.0	0.52
	CT81-1KV-10*-2E4-682M-*T*	10.0	4.0	5.0	0.52
	CT81-1KV-12*-2E4-103M-*T*	12.5	4.0	5.0	0.52
	CT81-1KV-06*-2F4-222M-*T*	6.5	4.0	5.0	0.52
	CT81-1KV-08*-2F4-472M-*T*	8.5	4.0	5.0	0.52
	CT81-1KV-10*-2F4-103M-*T*	10.0	4.0	5.0	0.52

编码 code	品名 (CODE NO.)	Dmax (mm)	Tmax (mm)	F (mm)	d (mm)
	CT81-1KV-06*-2R4-101K-*T*	6.5	4.0	5.0	0.52
	CT81-1KV-06*-2R4-151K-*T*	6.5	4.0	5.0	0.52
	CT81-1KV-06*-2R4-221K-*T*	6.5	4.0	5.0	0.52
	CT81-1KV-06*-2R4-331K-*T*	6.5	4.0	5.0	0.52
	CT81-1KV-08*-2R4-471K-*T*	8.5	4.0	5.0	0.52
	CT81-1KV-08*-2R4-561K-*T*	8.5	4.0	5.0	0.52
	CT81-1KV-08*-2R4-681K-*T*	8.5	4.0	5.0	0.52
	CT81-1KV-10*-2R4-821K-*T*	10.0	4.0	5.0	0.52
	CT81-1KV-10*-2R4-102K-*T*	10.0	4.0	5.0	0.52
	CT81-1KV-12*-2R4-152K-*T*	12.5	4.0	5.0	0.52
	CT81-1KV-12*-2R4-222K-*T*	12.5	4.0	5.0/7.5	0.52
	CT81-1KV-06*-HR-101K-*T*	6.5	4.0	5.0	0.52
	CT81-1KV-06*-HR-151K-*T*	6.5	4.0	5.0	0.52
	CT81-1KV-06*-HR-221K-*T*	6.5	4.0	5.0	0.52
	CT81-1KV-06*-HR-331K-*T*	6.5	4.0	5.0	0.52
	CT81-1KV-08*-HR-471K-*T*	8.5	4.0	5.0	0.52
	CT81-1KV-08*-HR-561K-*T*	8.5	4.0	5.0	0.52
	CT81-1KV-08*-HR-681K-*T*	8.5	4.0	5.0	0.52
	CT81-1KV-10*-HR-821K-*T*	10.0	4.0	5.0	0.52
	CT81-1KV-10*-HR-102K-*T*	10.0	4.0	5.0	0.52
	CT81-1KV-12*-HR-152K-*T*	12.5	4.0	5.0	0.52
	CT81-1KV-12*-HR-222K-*T*	12.5	4.0	5.0/7.5	0.52

编码 code	品名 (CODE NO.)	D <sub>max</sub> (mm)	T <sub>max</sub> (mm)	F (mm)	d (mm)
	CT81-2KV-06*-2B4-101K-*T*	6.5	5.0	5.0	0.52
	CT81-2KV-06*-2B4-151K-*T*	6.5	5.0	5.0	0.52
	CT81-2KV-06*-2B4-221K-*T*	6.5	5.0	5.0	0.52
	CT81-2KV-06*-2B4-331K-*T*	6.5	5.0	5.0	0.52
	CT81-2KV-06*-2B4-391K-*T*	6.5	5.0	5.0	0.52
	CT81-2KV-06*-2B4-471K-*T*	6.5	5.0	5.0/7.5	0.52
	CT81-2KV-06*-2B4-561K-*T*	6.5	5.0	5.0/7.5	0.52
	CT81-2KV-08*-2B4-681K-*T*	8.5	5.0	5.0/7.5	0.52
	CT81-2KV-08*-2B4-821K-*T*	8.5	5.0	5.0/7.5	0.52
	CT81-2KV-08*-2B4-102K-*T*	8.5	5.0	5.0/7.5	0.52
	CT81-2KV-09*-2B4-122K-*T*	9.5	5.0	5.0/7.5	0.52
	CT81-2KV-09*-2B4-152K-*T*	9.5	5.0	5.0/7.5	0.52
	CT81-2KV-09*-2B4-182K-*T*	9.5	5.0	5.0/7.5	0.52
	CT81-2KV-11*-2B4-222K-*T*	11.0	5.0	5.0/7.5	0.52
	CT81-2KV-06*-2E4-102M-*T*	6.5	5.0	5.0/7.5	0.52
	CT81-2KV-08*-2E4-152M-*T*	8.5	5.0	5.0/7.5	0.52
	CT81-2KV-08*-2E4-222M-*T*	8.5	5.0	5.0/7.5	0.52
	CT81-2KV-08*-2E4-332M-*T*	8.5	5.0	5.0/7.5	0.52
	CT81-2KV-11*-2E4-472M-*T*	11.0	5.0	5.0/7.5	0.52
	CT81-2KV-08*-2F4-332M-*T*	8.5	5.0	5.0/7.5	0.52
	CT81-2KV-08*-2F4-472M-*T*	8.5	5.0	5.0/7.5	0.52
	CT81-2KV-11*-2F4-103M-*T*	11.0	5.0	5.0/7.5	0.52
	CT81-2KV-06*-2R4-101K-*T*	6.5	5.0	5.0	0.52
	CT81-2KV-06*-2R4-151K-*T*	6.5	5.0	5.0	0.52
	CT81-2KV-06*-2R4-221K-*T*	6.5	5.0	5.0	0.52
	CT81-2KV-08*-2R4-331K-*T*	8.5	5.0	5.0	0.52
	CT81-2KV-08*-2R4-391K-*T*	8.5	5.0	5.0	0.52
	CT81-2KV-08*-2R4-471K-*T*	8.5	5.0	5.0/7.5	0.52
	CT81-2KV-09*-2R4-561K-*T*	9.5	5.0	5.0/7.5	0.52
	CT81-2KV-09*-2R4-681K-*T*	9.5	5.0	5.0/7.5	0.52
	CT81-2KV-12*-2R4-102K-*T*	12.5	5.0	5.0/7.5	0.52
	CT81-2KV-14*-2R4-152K-*T*	14.5	5.0	5.0/7.5	0.52
	CT81-2KV-06*-HR-101K-*T*	6.5	5.0	5.0	0.52
	CT81-2KV-06*-HR-151K-*T*	6.5	5.0	5.0	0.52
	CT81-2KV-06*-HR-221K-*T*	6.5	5.0	5.0	0.52
	CT81-2KV-08*-HR-331K-*T*	8.5	5.0	5.0	0.52
	CT81-2KV-08*-HR-391K-*T*	8.5	5.0	5.0	0.52
	CT81-2KV-08*-HR-471K-*T*	8.5	5.0	5.0/7.5	0.52
	CT81-2KV-09*-HR-561K-*T*	9.5	5.0	5.0/7.5	0.52
	CT81-2KV-09*-HR-681K-*T*	9.5	5.0	5.0/7.5	0.52
	CT81-2KV-12*-HR-102K-*T*	12.5	5.0	5.0/7.5	0.52
	CT81-2KV-14*-HR-152K-*T*	14.5	5.0	5.0/7.5	0.52

注：“\*”表示根据客户要求(Note: “\*” indicates according to customer requirements.)

□ 标识方法 (Marking)

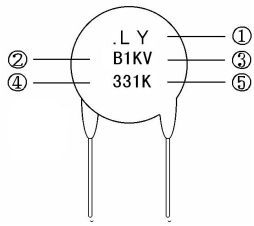
	① 公司代号 Manufacturer's Code
	② 温度特性 Temperature Characteristic
	③ 额定电压 Rated Voltage
	④ 标称容量 Rated Capacitance
	⑤ 容量偏差 Tolerance of Capacitance

□ 引线形式 Lead Shape

散件 (bulk): (单位: mm)

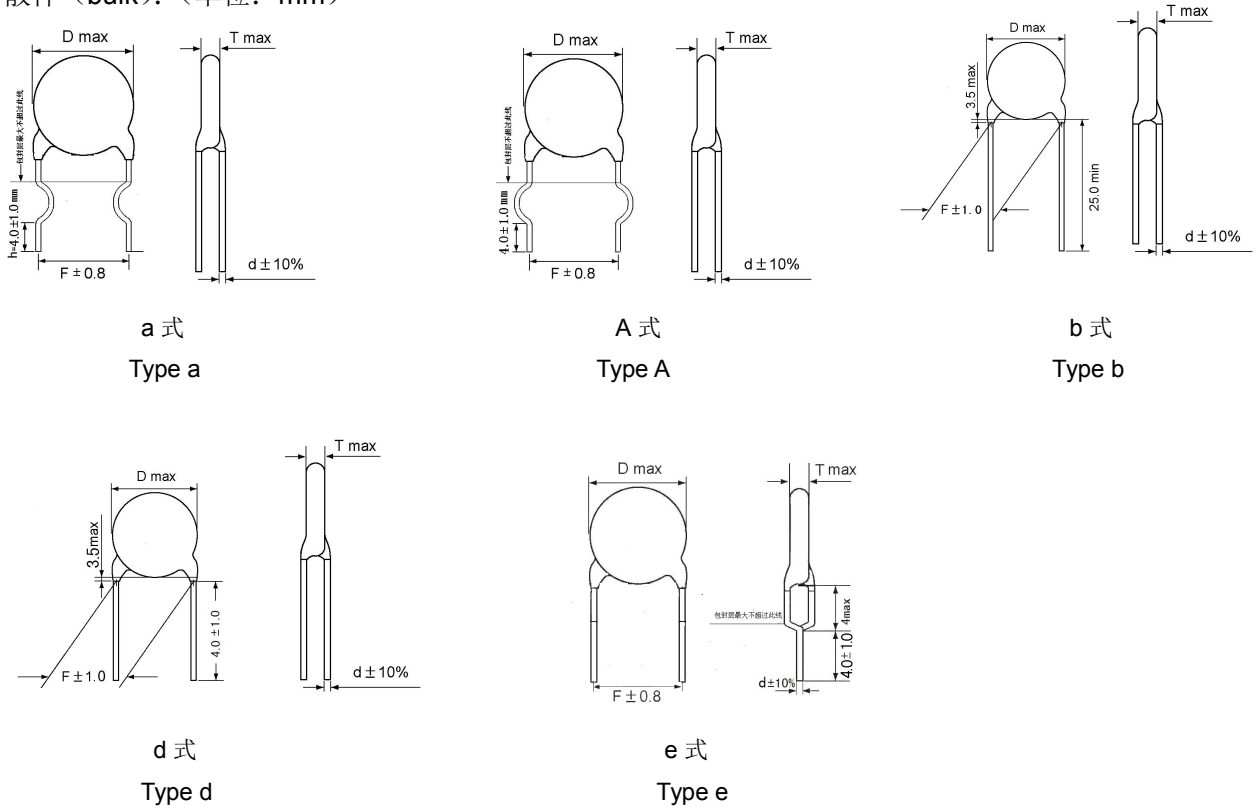

注: 引线长度根据客户要求 (Note: lead length according to customer requirements)



编带 (Taping Package):

● A, a, b 式 引线间距  $F=5.0\text{mm}$ ;  $P=P_0=12.7\text{mm}$

Type A,a,b (lead spacing  $F=5.0\text{mm}$ ;  $P=P_0=12.7\text{mm}$ )

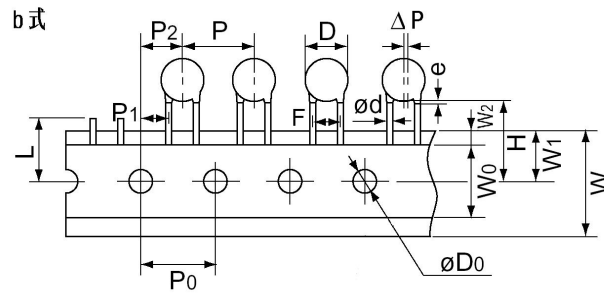
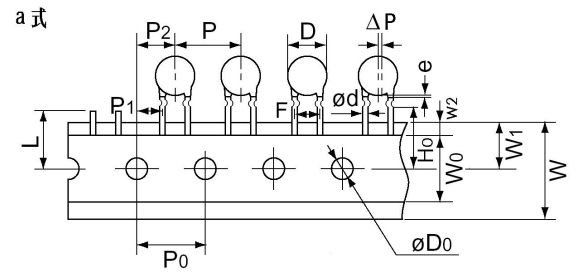
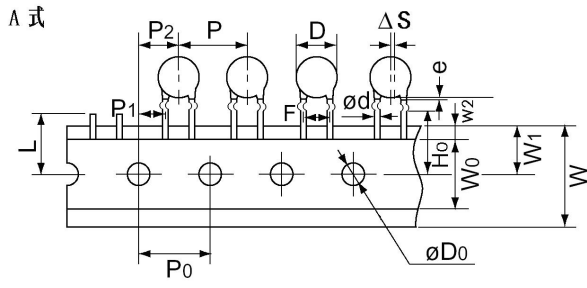

● A,b,e 式 引线间距  $F=7.5\text{mm}$ ;  $P=P_0=12.7\text{mm}$   
 Type A,b,e (lead spacing  $F=7.5\text{mm}$   $P=P_0=12.7\text{mm}$ )

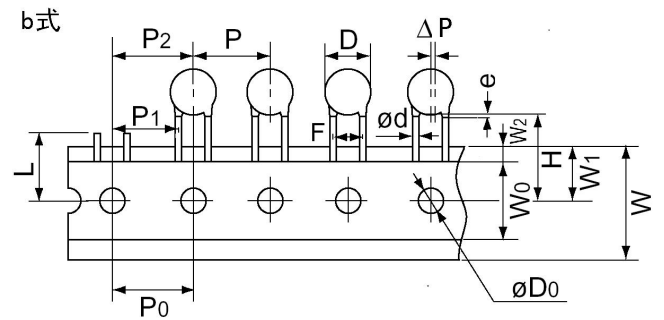
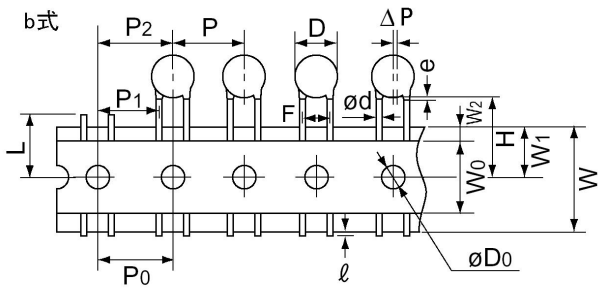
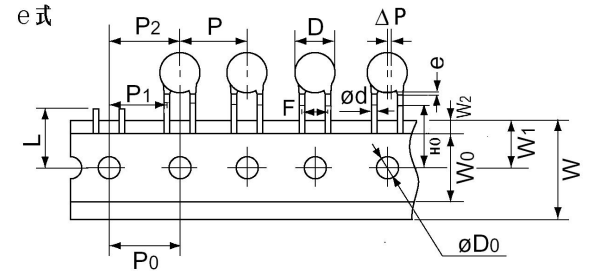
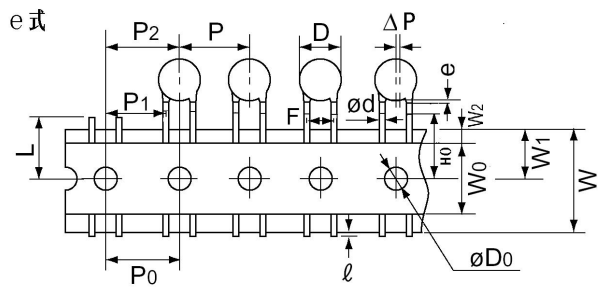
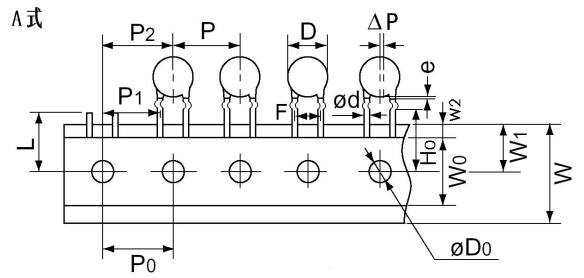
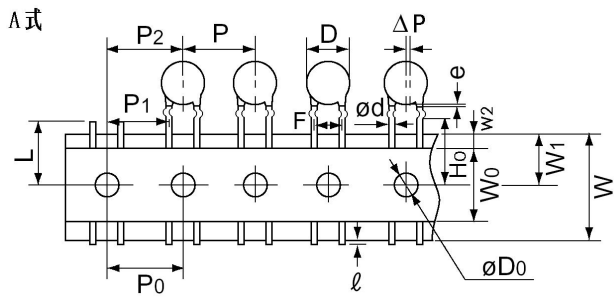

●A,b,e 式 (引线间距  $F=7.5\text{mm}$  产品间距  $P=P_0=15.0\text{mm}$ )

Type A, b, e (lead spacing  $F=7.5\text{mm}$  Product spacing  $P=P_0=15.0\text{mm}$ )

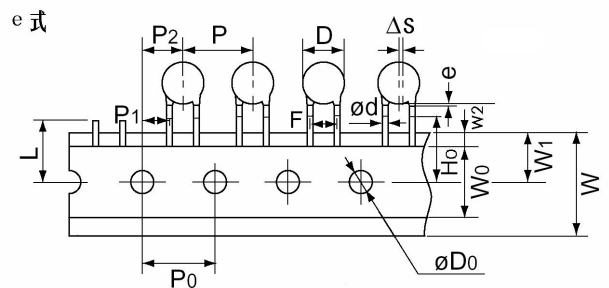
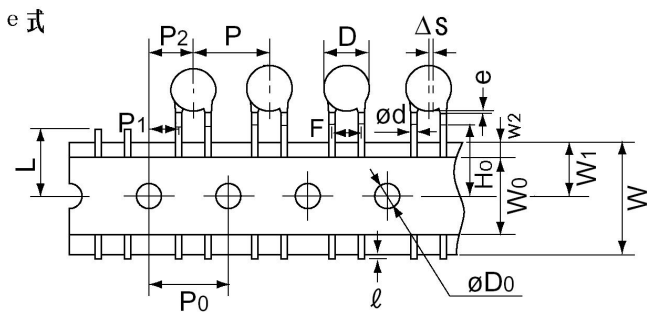
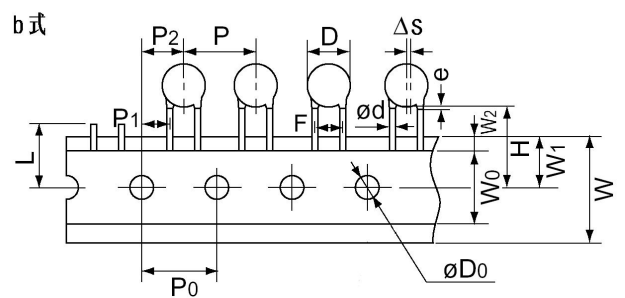
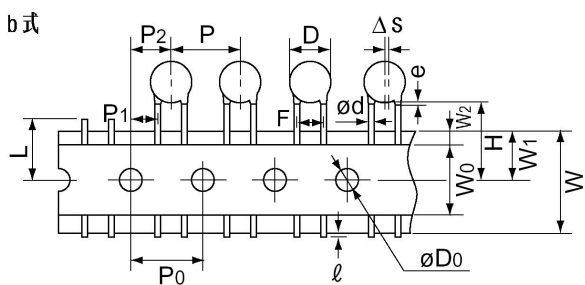
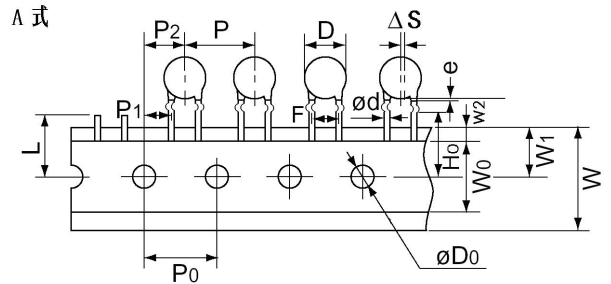
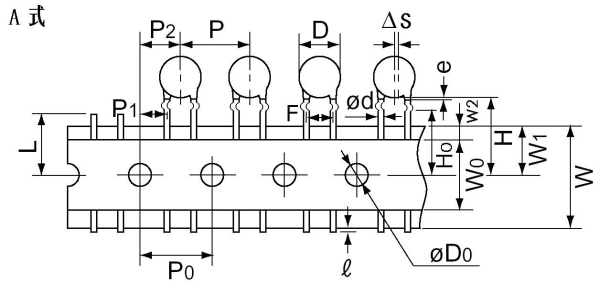

注：左侧编带图为一次编带，右侧编带图为二次编带 (left banding diagram is primary banding ;right banding diagram is secondary banding.)

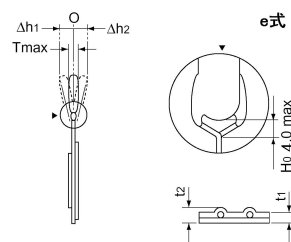
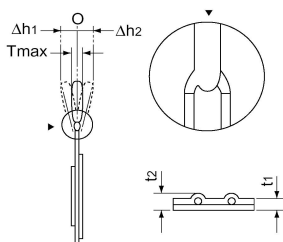

项目 Item	代号 Code	A、a、e 式 Type A、a、e			b 式 Type b		
引线间距 Lead spacing	F	5.0±0.6	7.5±1.0		5.0±0.6	7.5±1.0	
产品间距 Pitch of component	P	12.7±0.5	12.7±0.5	15.0±1.0	12.7±0.5	12.7±0.5	15.0±1.0
传送孔间距 Pitch of sprocket hole	P0	12.7±0.3	12.7±0.3	15.0±0.3	12.7±0.3	12.7±0.3	15.0±0.3
传送孔位置偏差 Position of sprocket hole	P1	3.85±0.7	8.95±1.0	3.75±0.7	3.85±0.7	8.95±1.0	3.75±0.7
	P2	6.35±1.3	12.7±1.3	7.5±1.3	6.35±1.3	12.7±1.3	7.5±1.3
引线线径 Lead diameter	d	0.52±0.052					
产品倾倒 Deviation across tape	Δh	2.0max					
纸带宽度 Carrier tape width	W	18.0±0.5					
胶带宽度 Hold-down tape width	W0	6.0min					
传送孔位置偏差 Position of sprocket	W1	9.0±0.5					
胶带偏差 Hold-down tape distortion	W2	1.5±1.5					
产品至纸带中心位置 Lead distance between reference and bottom planes	H	----			20±2	20.0 +1.5/-1.0	
引线弯处到传送孔中心 Lead distance between reference And kink lead	H0	16.0-0.5/+1.0	16.0-0.5/+1.5		----		
传送孔孔径 Diameter of sprocket hole	D0	4.0±0.2					
不良切断位置 Portion to cut	L	11.0 max					
封装料垂延 Coating extension on lead	e	不过弯中央 No over the center of crim			3.5max		
纸带厚度 thickness of tape	t1	0.5±0.3					
	t2	1.5max					
引线弹性弯曲 Lead flexible bend	ΔS/ ΔP	0±2.0					
引线尾端长度 Lead the end of length	ℓ	1.0max					

## □结构(Structure)

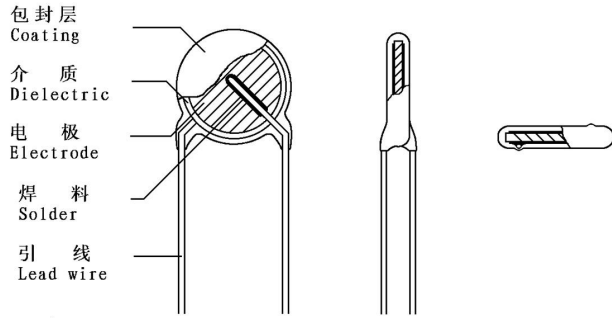

包封层(Coating) : 环氧树脂(Epoxy Resin)

介质(Dielectric): 陶瓷 (Ceramic)

电极(Electrode) : 银 (Silver)

焊料(Solder) : 锡(Alloy Tin)

引线(Lead Wire) : 镀锡引出线(Lead)

## □主要材料(Main Material)

$SrCO_3$   $BaCO_3$   $TiO_2$   $Bi_2O_3$   $CaCO_3$   $Nb_2O_5$   $MgO$

银膏(Silver paste) 环氧树脂(Epoxy Resin)

## □室内条件(Room Condition)

温度(Temp.): 15~35°C 湿度(R. H.): 45~75%

气压(Atm pressure): 86~106kPa (860~1060mbar)

## □测试条件(Test Condition)

温度(Temp.): 20±2°C 湿度(R. H.): 50~60%

电压(Vol.): 1.0±0.2Vrms 频率(Freq.): 1±0.2KHz

## □容量—温度变化曲线 Cap.—Temp. Curve

2B4 组

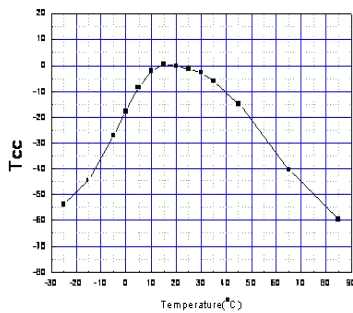

2R4 组

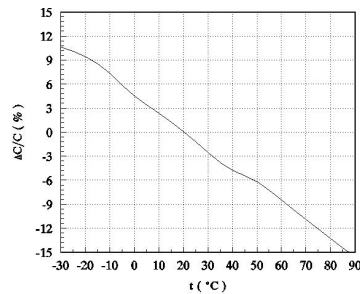

HR 组

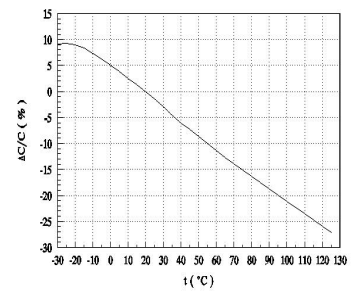

2E4 组

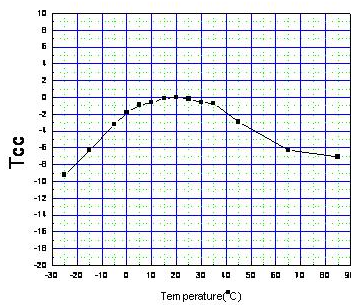

2F4 组

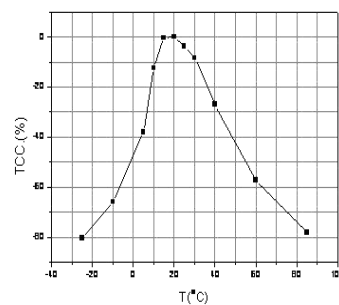

## □型号命名方法 Part Code Designation

CT81—1KV—06 a—2B4—331 K—1 T1

①            ②            ③ ④            ⑤            ⑥ ⑦            ⑧ ⑨

### ①种类 Class

代码 Code	种类 Class
CT81	II类高压 Class II High-Voltage

### ⑤温度特性 Temperature Characteristic

代码 Code	容量变化 Cap. Change
2B4	-10~+10%
2R4	-15~+15%
HR	-30~+15%
2E4	-56~+22%
2F4	-80~+30%

### ②额定电压 Rated Voltage

代码 Code	额定电压 Rated Vol.	代码 Code	额定电压 Rated Vol.
1KV	1000V. DC	4KV	4000V. DC
2KV	2000V. DC	6KV	6000V. DC
3KV	3000V. DC		

### ⑥标称容量 Rated Capacitance

代码 Code	静电容量 Capacitance	代码 Code	静电容量 Capacitance
101	100pF	152	1500pF
151	150pF	203	20000pF
以此类推 And so on			

### ③主体外径 Body Diameter

代码 Code	最大外径 Max Diameter of Body	代码 Code	最大外径 Max Diameter of Body
06	6.5mm	11	11.0mm
07	7.5mm	12	12.5mm
08	8.5mm	13	13.0mm
09	9.5mm	14	14.5mm
10	10.0mm	16	16.0mm

### ⑦容量允差 Tolerance

代码 Code	容量允差 Tolerance
K	±10%
M	±20%
Z	-20~+80%

### ④引线形式 Lead Shape

代码 Code	形式 Shape
a	单内弯 Single inside Crimp
A	单外弯 Single outside Crimp
b	直脚 Straight long
d	短直脚 Straight Short
e	前后弯 Vertical crimp

### ⑧引线间距 lead space

代码 Code	间距 spacing
1	5.0mm
2	7.5mm
3	10.0mm

### ⑨包装方式 package Shape

代码 Code	形式 Shape
T1	P0=12.7mm P=12.7mm
T3	P0=15.0mm P=15.0mm
无标识 No mark	散件 (Bulk)



□包装 (packing)

散件包装 (bulk packing)

1、包装数量 (packing quantity):

成型方式 Molding mode	袋装数量(支) Quantity per bag (PCS)	备注 Remark
A、a、d、b、e	1000±1/500±1	塑料袋尺寸: Size of plastic bag 1#: 275×200mm 2#: 215×160mm

2、包装标识 (packing marking):

示例(Example)	项 目 ( Item )	
		公司商标 (Manufacturer's Marking)
		环保标识 RoHS Designation
	物料编码 Code	用户要求时 When the customer require
	规格型号 Model	详见如上表格, (Please see the detail in the upper sheet)
	生产批号 Product lots	生产批号 Product lots
	成型代号 lead shape	用户要求时 When the customer require
	生产日期 Productive date	产品生产时间 the produce time of the product
	数 量 Quantity	每盒的包装数量 the packing quantity per plastic bag

3、外包装 (over-wrap packing):

内包装箱 (internal packing boxes) (A1:360×200×140mm、A2:198×177×138mm)

外包装箱 (over-wrap boxes) (B1:460×380×220mm、B2:425×380×170mm)

装箱数量应为最小包装的整数倍。(The packing quantity should be integral multiple of minimal packaging. )

编带包装 (Taping Package packing)

1、包装数量 (packing quantity):

引线间距 Lead spacing	包装盒分类 Kinds of plastic box	成型方式 Molding mode	包装数量 Quantity per bag	备注 Remark
F=5.0mm	1# 2#	A、a、b	2000	包装盒尺寸: Size of plastic box 1#: 336×240×45mm 2#: 336×290×48mm
F=7.5mm	1# 2#	A、b、e	1000~2000	

3、包装标识 (packing marking):

示例(Example)	项 目 ( Item )	
		公司商标 (Manufacturer's Marking)
		环保标识 RoHS Designation
	物料编码 Code	用户要求时 When the customer require
	规格型号 Model	详见如上表格, (Please see the detail in the upper sheet)
	生产批号 Product lots	生产批号 Product lots
	成型代号 lead shape	用户要求时 When the customer require
	生产日期 Productive date	产品生产时间 the produce time of the product
	数 量 Quantity	每盒的包装数量 the packing quantity per plastic bag

3、外包装 (over-wrap packing):

内包装箱 (internal packing boxes) (A1:360×200×140mm、A2:198×177×138mm)

外包装箱 (over-wrap boxes) (B1:460×380×220mm、B2:425×380×170mm)

装箱数量应为最小包装的整数倍。(The packing quantity should be integral multiple of minimal packaging. )