

# HCFL60R350

## 600V N-Channel Super Junction MOSFET

### Features

- Very Low FOM ( $R_{DS(on)} \times Q_g$ )
- Extremely low switching loss
- Excellent stability and uniformity
- 100% Avalanche Tested
- Built-in ESD Diode

### Application

- Switch Mode Power Supply (SMPS)
- Uninterruptible Power Supply (UPS)
- Power Factor Correction (PFC)
- TV power & LED Lighting Power
- AC to DC Converters
- Telecom

### Key Parameters

| Parameter              | Value | Unit     |
|------------------------|-------|----------|
| $BV_{DSS} @ T_{j,max}$ | 650   | V        |
| $I_D$                  | 11.1  | A        |
| $R_{DS(on), max}$      | 0.385 | $\Omega$ |
| $Q_g, Typ$             | 22.6  | nC       |

### Package & Internal Circuit

| DFN8x8 | SYMBOL |
|--------|--------|
|        |        |

### Absolute Maximum Ratings $T_C=25^\circ\text{C}$ unless otherwise specified

| Symbol         | Parameter  | Value       | Unit             |
|----------------|--|-------------|------------------|
| $V_{DSS}$      | Drain-Source Voltage   | 600         | V                |
| $V_{GS}$       | Gate-Source Voltage  | $\pm 20$    | V                |
| $I_D$          | Drain Current - Continuous ( $T_C = 25^\circ\text{C}$ )              | 11.1        | A                |
|                | Drain Current - Continuous ( $T_C = 100^\circ\text{C}$ )             | 7.0         | A                |
| $I_{DM}^{1)}$  | Drain Current - Pulsed   | 33          | A                |
| $E_{AS}^{2)}$  | Single Pulsed Avalanche Energy                                       | 141         | mJ               |
| $I_{AR}$       | Avalanche Current  | 1.8         | A                |
| dv/dt          | MOSFET dv/dt ruggedness, $V_{DS}=0\dots 400\text{V}$                 | 50          | V/ns             |
| dv/dt          | Reverse diode dv/dt, $V_{DS}=0\dots 400\text{V}$ , $I_{DS} \leq I_D$ | 15          | V/ns             |
| $P_D$          | Power Dissipation ( $T_C = 25^\circ\text{C}$ )                       | 104         | W                |
| $V_{ESD(G-S)}$ | Gate source ESD(HBM-C=100pF, R=1.5K $\Omega$ )                       | 2000        | V                |
| $T_J, T_{STG}$ | Operating and Storage Temperature Range                              | -55 to +150 | $^\circ\text{C}$ |

### Thermal Resistance Characteristics

| Symbol          | Parameter                                     | Value | Unit               |
|-----------------|---|-------|--------------------|
| $R_{\theta JC}$ | Thermal Resistance, Junction-to-Case, Max.    | 1.2   | $^\circ\text{C/W}$ |
| $R_{\theta JA}$ | Thermal Resistance, Junction-to-Ambient, Max. | 62.5  | $^\circ\text{C/W}$ |

**Electrical Characteristics**  $T_J=25^\circ\text{C}$  unless otherwise specified

| Symbol  | Parameter   | Test Conditions   | Min | Typ   | Max     | Unit          |
|---|---|---|-----|-------|---------|---------------|
| <b>On Characteristics</b>                                     |   |   |     |       |         |               |
| $V_{GS}$  | Gate Threshold Voltage                                | $V_{DS} = V_{GS}, I_D = 370 \mu\text{A}$  | 2.0 | -     | 4.0     | V             |
| $R_{DS(ON)}$  | Static Drain-Source On-Resistance                     | $V_{GS} = 10 \text{ V}, I_D = 3.8 \text{ A}$  | -   | 0.335 | 0.385   | $\Omega$      |
| <b>Off Characteristics</b>                                    |   |   |     |       |         |               |
| $BV_{DSS}$  | Drain-Source Breakdown Voltage                        | $V_{GS} = 0 \text{ V}, I_D = 1 \text{ mA}$  | 600 | -     | -       | V             |
| $I_{DSS}$   | Zero Gate Voltage Drain Current                       | $V_{DS} = 600 \text{ V}, V_{GS} = 0$  | -   | -     | 1       | $\mu\text{A}$ |
|   |   | $V_{DS} = 600 \text{ V}, T_C = 150^\circ\text{C}$   | -   | -     | 100     | $\mu\text{A}$ |
| $I_{GSS}$   | Gate-Body Leakage Current                             | $V_{GS} = \pm 20 \text{ V}, V_{DS} = 0 \text{ V}$   | -   | -     | $\pm 1$ | $\mu\text{A}$ |
| <b>Dynamic Characteristics</b>                                |   |   |     |       |         |               |
| $C_{iss}$   | Input Capacitance                                     | $V_{DS} = 400 \text{ V}, V_{GS} = 0 \text{ V},$<br>$f = 1.0 \text{ MHz}$                    | -   | 990   | -       | pF            |
| $C_{oss}$   | Output Capacitance                                    |   | -   | 25    | -       | pF            |
| $C_{rss}$   | Reverse Transfer Capacitance                          |   | -   | 2.4   | -       | pF            |
| <b>Switching Characteristics</b>                              |   |   |     |       |         |               |
| $t_{d(on)}$   | Turn-On Time  | $V_{DS} = 300 \text{ V}, I_D = 4.8 \text{ A},$<br>$R_G = 25 \Omega$<br><br>(Note 3,4)       | -   | 28    | -       | ns            |
| $t_r$   | Turn-On Rise Time                                     |   | -   | 20    | -       | ns            |
| $t_{d(off)}$  | Turn-Off Delay Time                                   |   | -   | 114   | -       | ns            |
| $t_f$   | Turn-Off Fall Time                                    |   | -   | 17    | -       | ns            |
| $Q_{g()}$   | Total Gate Charge                                     | $V_{DS} = 480 \text{ V}, I_D = 4.8 \text{ A},$<br>$V_{GS} = 10 \text{ V}$<br><br>(Note 3,4) | -   | 22.6  | -       | nC            |
| $Q_{gs}$  | Gate-Source Charge                                    |   | -   | 4.6   | -       | nC            |
| $Q_{gd}$  | Gate-Drain Charge                                     |   | -   | 6.4   | -       | nC            |
| <b>Drain-Source Diode Characteristics and Maximum Ratings</b> |   |   |     |       |         |               |
| $I_S$   | Maximum Continuous Drain-Source Diode Forward Current |   | -   | -     | 11.1    | A             |
| $I_{SM}$  | Maximum Pulsed Drain-Source Diode Forward Current     |   | -   | -     | 33      | A             |
| $V_{SD}$  | Drain-Source Diode Forward Voltage                    | $V_{GS} = 0 \text{ V}, I_S = 4.8 \text{ A}$   | -   | -     | 1.3     | V             |
| $t_{rr}$  | Reverse Recovery Time                                 | $V_R = 400 \text{ V}, I_F = 4.8 \text{ A}$<br>$di_F/dt = 100 \text{ A}/\mu\text{s}$         | -   | 250   | -       | ns            |
| $Q_{rr}$  | Reverse Recovery Charge                               |   | -   | 2.6   | -       | $\mu\text{C}$ |

**Notes :**

1. Repetitive Rating : Pulse width limited by maximum junction temperature
2.  $I_{AS}=1.8\text{A}, V_{DD}=50\text{V}, R_G=25\Omega,$  Starting  $T_J=25^\circ\text{C}$
3. Pulse Test : Pulse Width  $\leq 300\mu\text{s},$  Duty Cycle  $\leq 2\%$
4. Essentially Independent of Operating Temperature

### Typical Characteristics

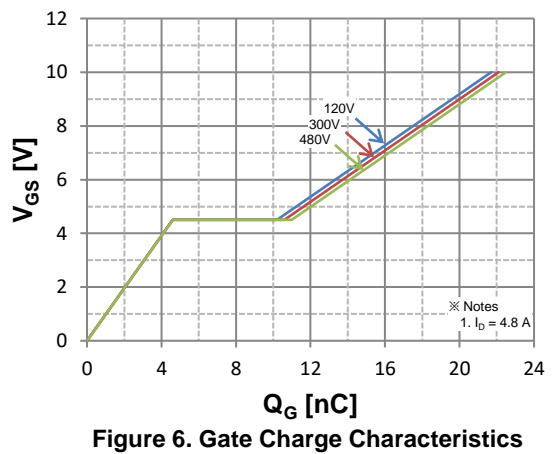
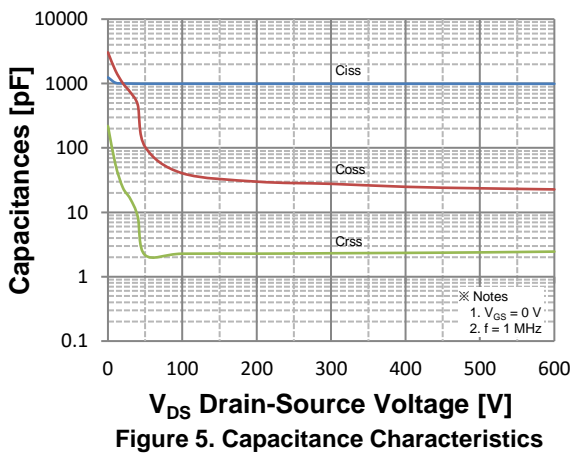
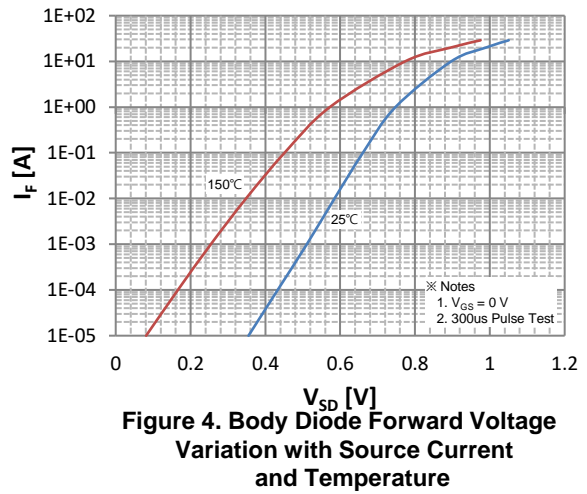
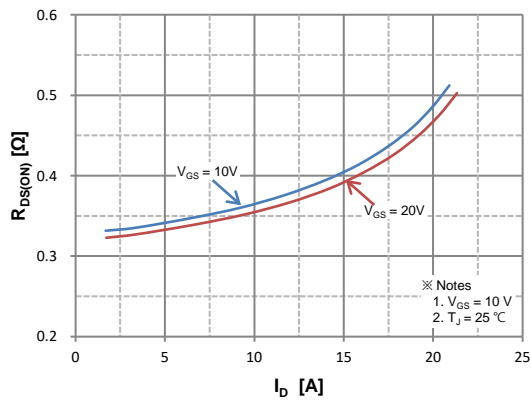
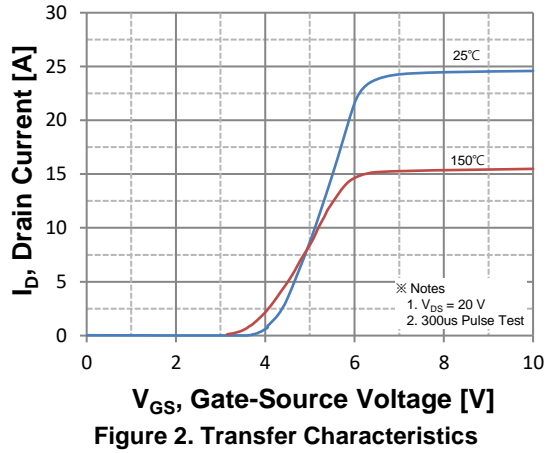
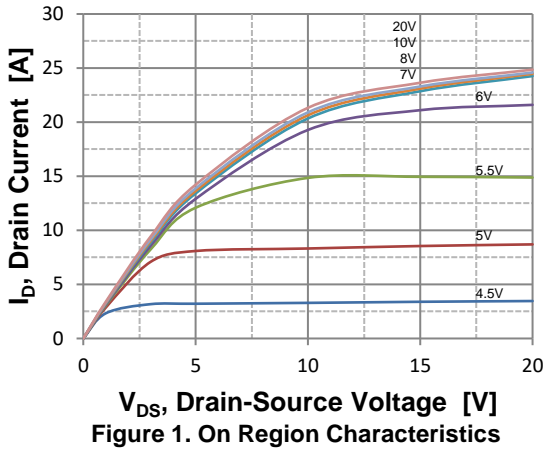

Typical Characteristics



Figure 7. Breakdown Voltage Variation vs. Temperature

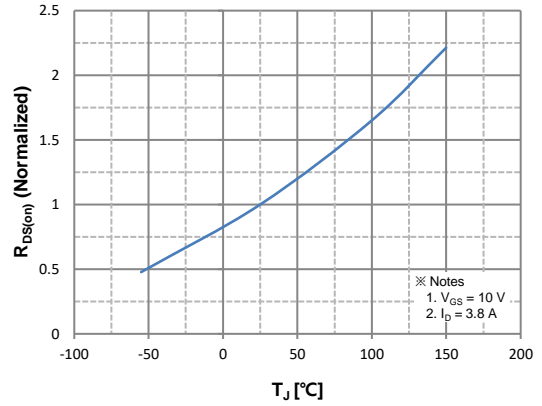

Figure 8. On-Resistance Variation vs. Temperature

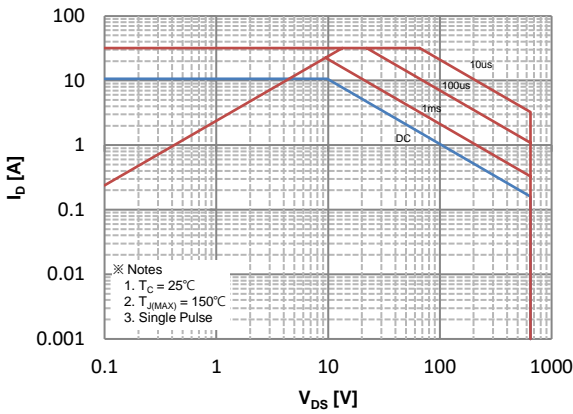

Figure 9. Maximum Safe Operating Area

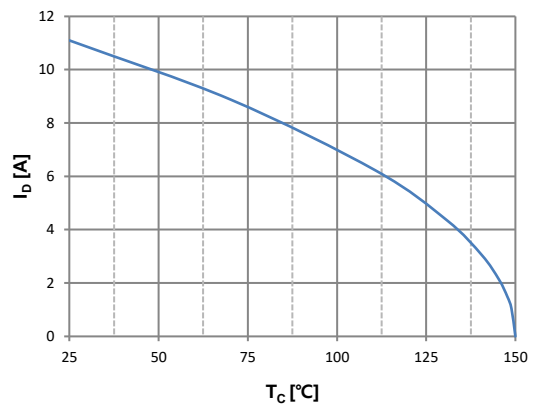

Figure 10. Maximum Drain Current vs. Case Temperature

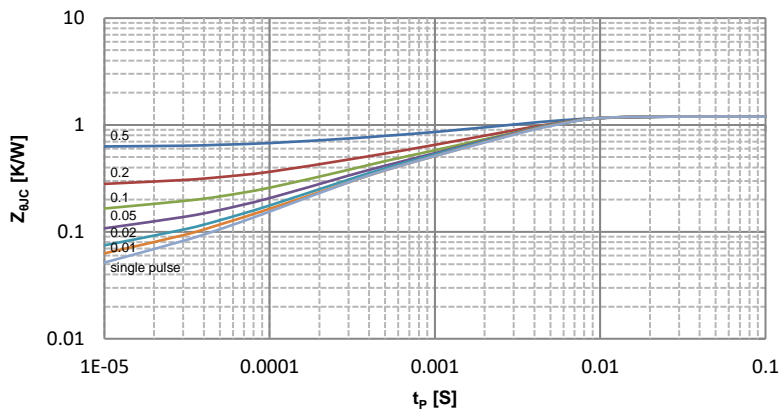

Figure 11. Transient Thermal Response Curve

Fig 12. Gate Charge Test Circuit & Waveform

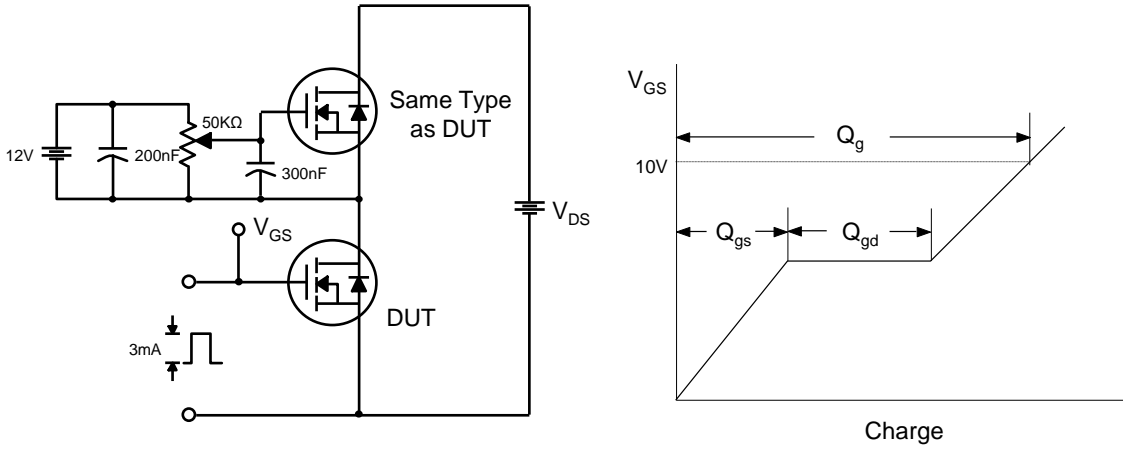

Fig 13. Resistive Switching Test Circuit & Waveforms

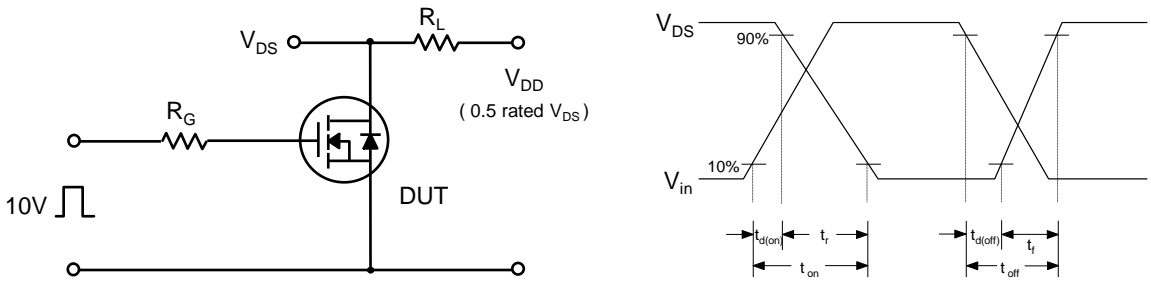

Fig 14. Unclamped Inductive Switching Test Circuit & Waveforms

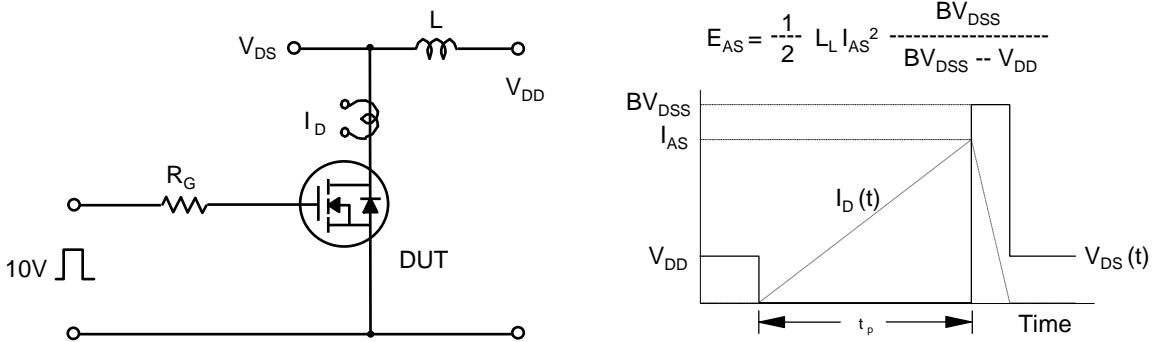
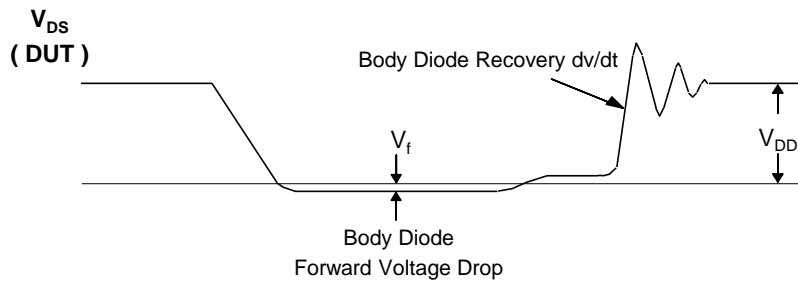
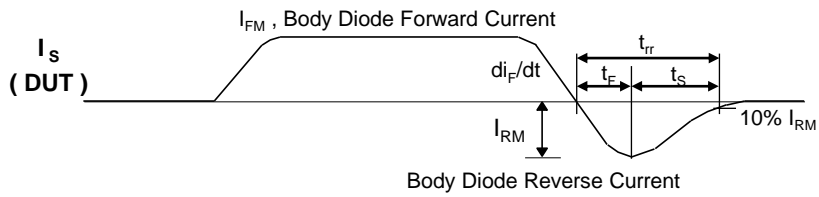
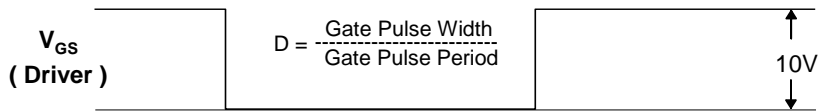

Fig 15. Peak Diode Recovery dv/dt Test Circuit & Waveforms



Package Dimension

DFN 8x8

