

# HCS60R350W

## 600V N-Channel Super Junction MOSFET

### Features

- Very Low FOM ( $R_{DS(on)} \times Q_g$ )
- Extremely low switching loss
- Excellent stability and uniformity
- 100% Avalanche Tested
- Built-in ESD Diode

### Application

- Switch Mode Power Supply (SMPS)
- Uninterruptible Power Supply (UPS)
- Power Factor Correction (PFC)
- TV power & LED Lighting Power
- AC to DC Converters
- Telecom

### Key Parameters

Parameter	Value	Unit
$BV_{DSS} @ T_{j,max}$	650	V
$I_D$	10.9	A
$R_{DS(on), max}$	0.35	$\Omega$
$Q_g, Typ$	22.6	nC

### Package & Internal Circuit

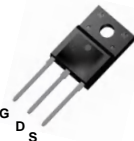
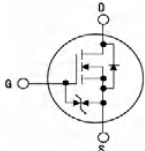
TO-220FW	SYMBOL
	

### Absolute Maximum Ratings $T_C=25^\circ\text{C}$ unless otherwise specified

Symbol	Parameter	Value	Unit
$V_{DSS}$	Drain-Source Voltage	600	V
$V_{GS}$	Gate-Source Voltage	$\pm 20$	V
$I_D$	Drain Current - Continuous ( $T_C = 25^\circ\text{C}$ )	10.9 *	A
	Drain Current - Continuous ( $T_C = 100^\circ\text{C}$ )	6.9 *	A
$I_{DM}^{1)}$	Drain Current - Pulsed	33.0 *	A
$E_{AS}^{2)}$	Single Pulsed Avalanche Energy	141	mJ
$I_{AR}$	Avalanche Current	1.8	A
dv/dt	MOSFET dv/dt ruggedness, $V_{DS}=0 \dots 400\text{V}$	50	V/ns
dv/dt	Reverse diode dv/dt, $V_{DS}=0 \dots 400\text{V}$ , $I_{DS} \leq I_D$	15	V/ns
$P_D$	Power Dissipation ( $T_C = 25^\circ\text{C}$ )	30	W
$V_{ESD(G-S)}$	Gate source ESD(HBM-C=100pF, R=1.5K $\Omega$ )	2000	V
$T_J, T_{STG}$	Operating and Storage Temperature Range	-55 to +150	$^\circ\text{C}$

\* Drain current limited by maximum junction temperature

### Thermal Resistance Characteristics

Symbol	Parameter	Value	Unit
$R_{\theta JC}$	Thermal Resistance, Junction-to-Case, Max.	4.1	$^\circ\text{C/W}$
$R_{\theta JA}$	Thermal Resistance, Junction-to-Ambient, Max.	80	$^\circ\text{C/W}$

**Electrical Characteristics**  $T_J=25^\circ\text{C}$  unless otherwise specified

Symbol	Parameter	Test Conditions	Min	Typ	Max	Unit
<b>On Characteristics</b>						
$V_{GS}$	Gate Threshold Voltage	$V_{DS} = V_{GS}, I_D = 370 \mu\text{A}$	2.0	-	4.0	V
$R_{DS(ON)}$	Static Drain-Source On-Resistance	$V_{GS} = 10 \text{ V}, I_D = 3.8 \text{ A}$	-	0.305	0.35	$\Omega$
<b>Off Characteristics</b>						
$BV_{DSS}$	Drain-Source Breakdown Voltage	$V_{GS} = 0 \text{ V}, I_D = 1 \text{ mA}$	600	-	-	V
$I_{DSS}$	Zero Gate Voltage Drain Current	$V_{DS} = 600 \text{ V}, V_{GS} = 0$	-	-	1	$\mu\text{A}$
		$V_{DS} = 600 \text{ V}, T_C = 150^\circ\text{C}$	-	-	100	$\mu\text{A}$
$I_{GSS}$	Gate-Body Leakage Current	$V_{GS} = \pm 20 \text{ V}, V_{DS} = 0 \text{ V}$	-	-	$\pm 1$	$\mu\text{A}$
<b>Dynamic Characteristics</b>						
$C_{iss}$	Input Capacitance	$V_{DS} = 400 \text{ V}, V_{GS} = 0 \text{ V},$ $f = 1.0 \text{ MHz}$	-	990	-	pF
$C_{oss}$	Output Capacitance		-	25	-	pF
$C_{rss}$	Reverse Transfer Capacitance		-	2.4	-	pF
<b>Switching Characteristics</b>						
$t_{d(on)}$	Turn-On Time	$V_{DS} = 300 \text{ V}, I_D = 4.8 \text{ A},$ $R_G = 25 \Omega$  (Note 3,4)	-	28	-	ns
$t_r$	Turn-On Rise Time		-	20	-	ns
$t_{d(off)}$	Turn-Off Delay Time		-	114	-	ns
$t_f$	Turn-Off Fall Time		-	17	-	ns
$Q_{g()}$	Total Gate Charge	$V_{DS} = 480 \text{ V}, I_D = 4.8 \text{ A},$ $V_{GS} = 10 \text{ V}$  (Note 3,4)	-	22.6	-	nC
$Q_{gs}$	Gate-Source Charge		-	4.6	-	nC
$Q_{gd}$	Gate-Drain Charge		-	6.4	-	nC
<b>Drain-Source Diode Characteristics and Maximum Ratings</b>						
$I_S$	Maximum Continuous Drain-Source Diode Forward Current		-	-	10.9	A
$I_{SM}$	Maximum Pulsed Drain-Source Diode Forward Current		-	-	33	A
$V_{SD}$	Drain-Source Diode Forward Voltage	$V_{GS} = 0 \text{ V}, I_S = 4.8 \text{ A}$	-	-	1.3	V
$t_{rr}$	Reverse Recovery Time	$V_R = 400 \text{ V}, I_F = 4.8 \text{ A}$ $di_F/dt = 100 \text{ A}/\mu\text{s}$	-	250	-	ns
$Q_{rr}$	Reverse Recovery Charge		-	2.6	-	$\mu\text{C}$

**Notes :**

1. Repetitive Rating : Pulse width limited by maximum junction temperature
2.  $I_{AS}=1.8\text{A}, V_{DD}=50\text{V}, R_G=25\Omega,$  Starting  $T_J=25^\circ\text{C}$
3. Pulse Test : Pulse Width  $\leq 300\mu\text{s},$  Duty Cycle  $\leq 2\%$
4. Essentially Independent of Operating Temperature

Typical Characteristics

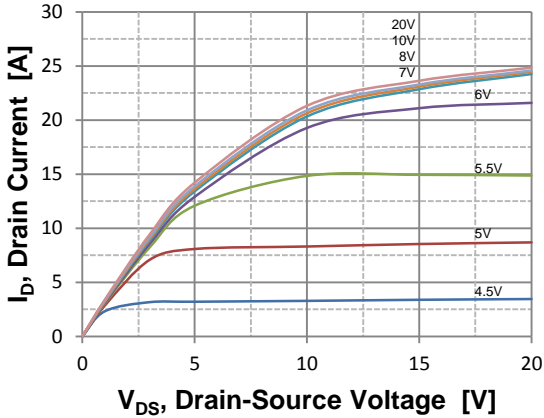

**V<sub>DS</sub>, Drain-Source Voltage [V]**  
**Figure 1. On Region Characteristics**

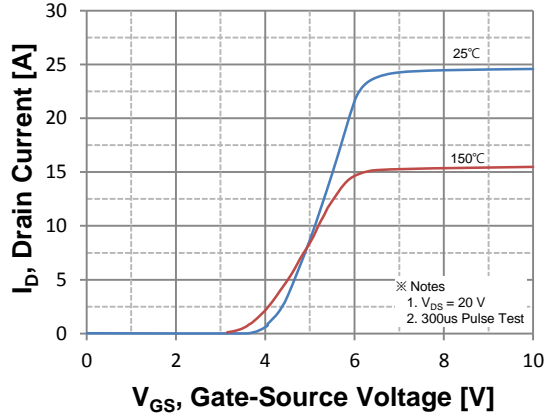

**V<sub>GS</sub>, Gate-Source Voltage [V]**  
**Figure 2. Transfer Characteristics**

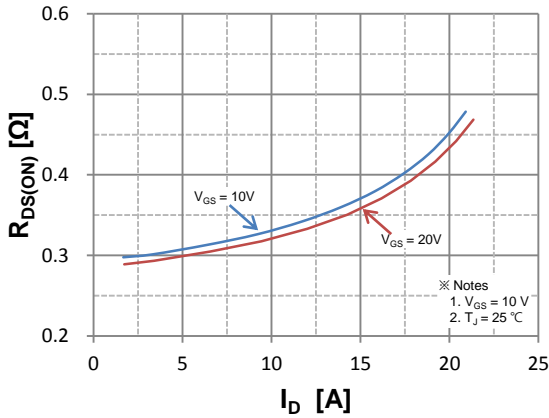

**I<sub>D</sub> [A]**  
**Figure 3. On Resistance Variation vs Drain Current and Gate Voltage**

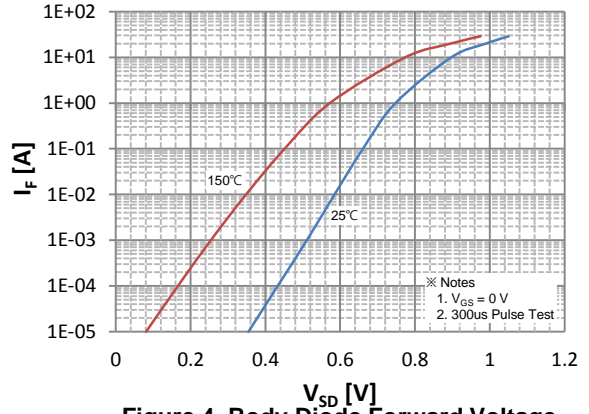

**V<sub>SD</sub> [V]**  
**Figure 4. Body Diode Forward Voltage Variation with Source Current and Temperature**

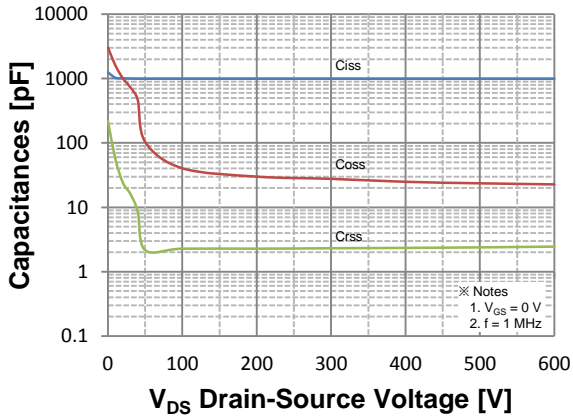

**V<sub>DS</sub> Drain-Source Voltage [V]**  
**Figure 5. Capacitance Characteristics**

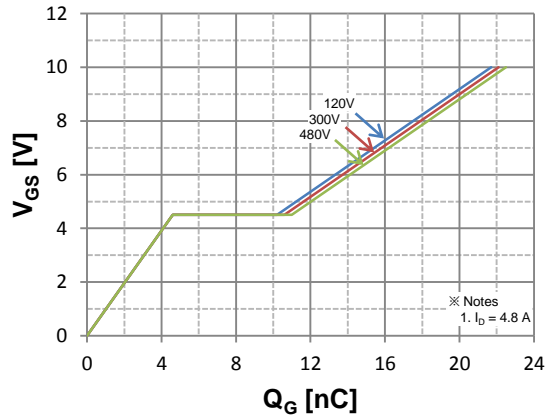

**Q<sub>G</sub> [nC]**  
**Figure 6. Gate Charge Characteristics**

Typical Characteristics (continued)

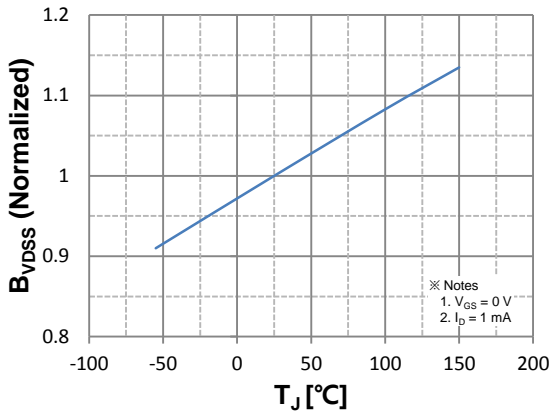

Figure 7. Breakdown Voltage Variation vs. Temperature

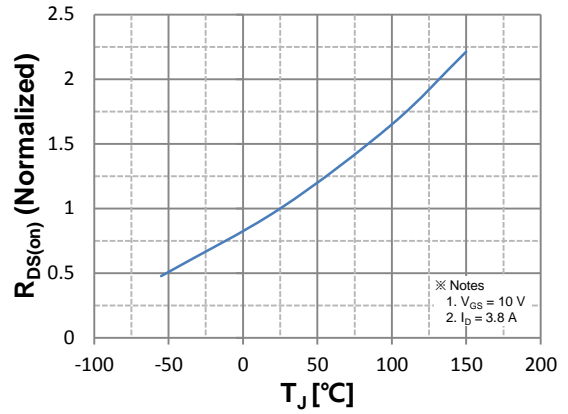

Figure 8. On-Resistance Variation vs. Temperature

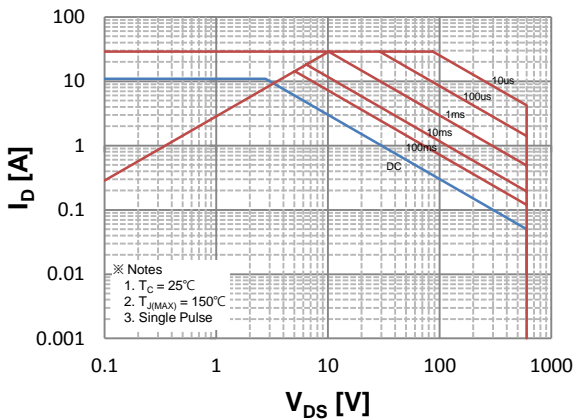

Figure 9. Maximum Safe Operating Area

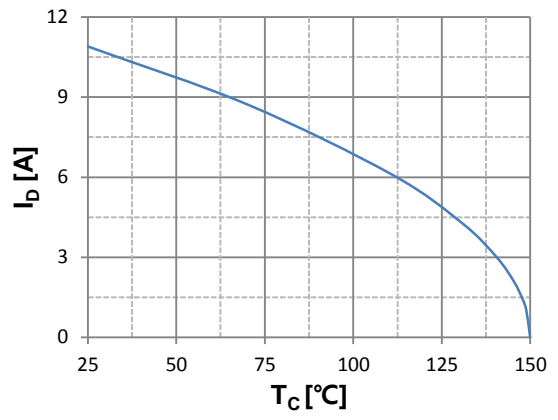

Figure 10. Maximum Drain Current vs. Case Temperature

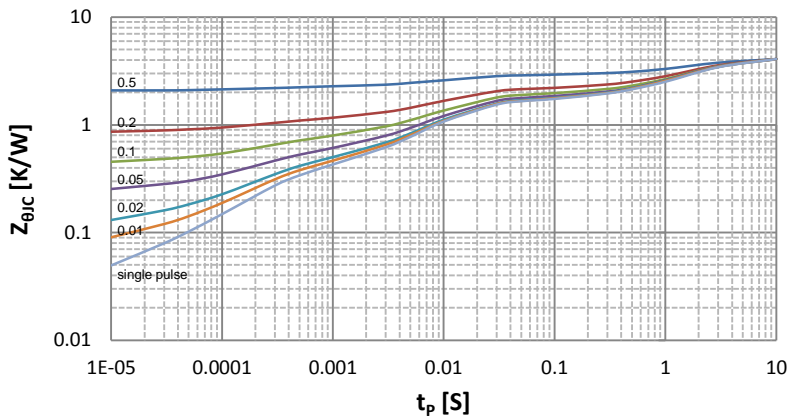

Figure 11. Transient Thermal Response Curve

Fig 12. Gate Charge Test Circuit & Waveform



Fig 13. Resistive Switching Test Circuit & Waveforms

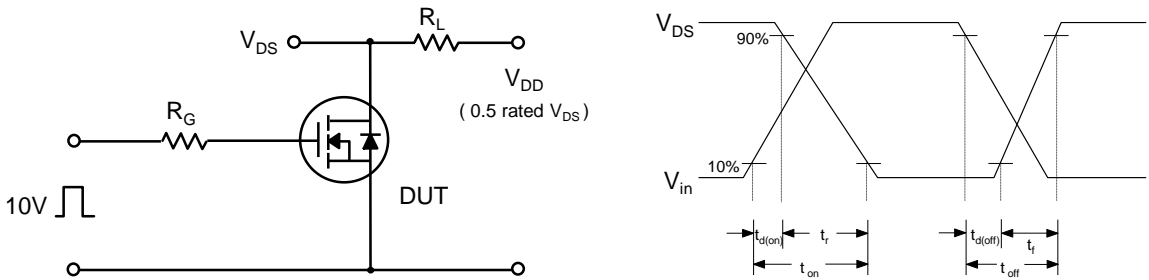

Fig 14. Unclamped Inductive Switching Test Circuit & Waveforms

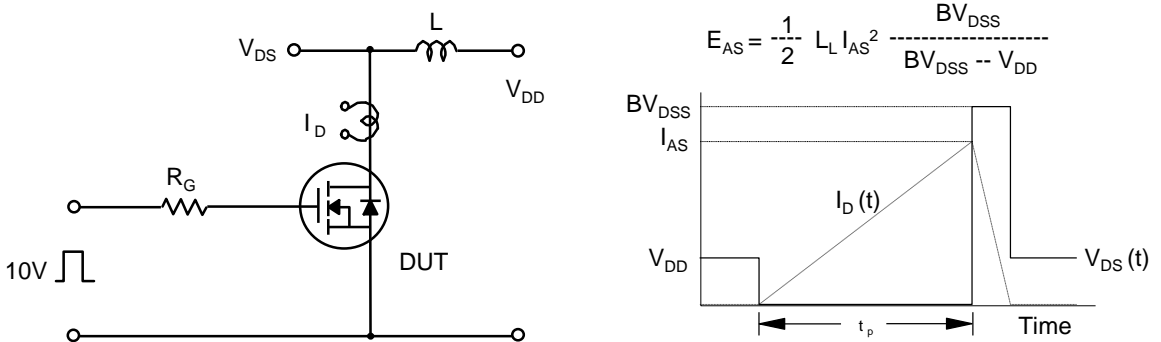

Fig 15. Peak Diode Recovery dv/dt Test Circuit & Waveforms



Package Dimension

TO-220FW

TOP VIEW

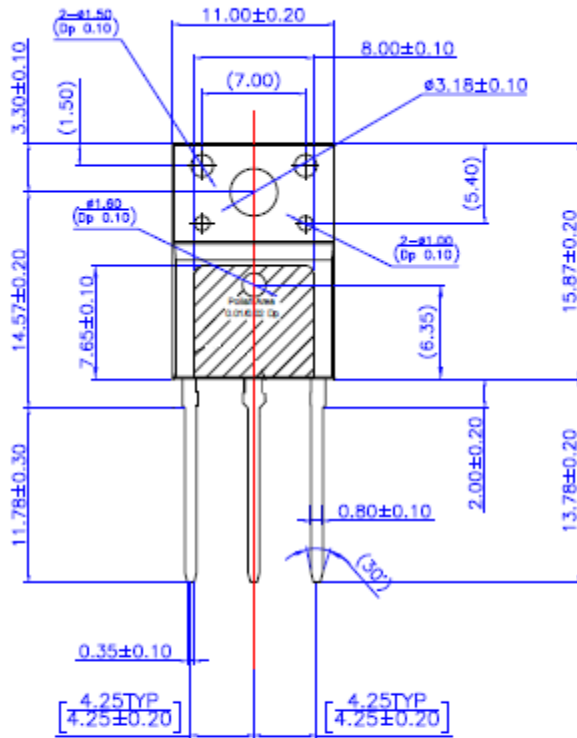

BTM VIEW

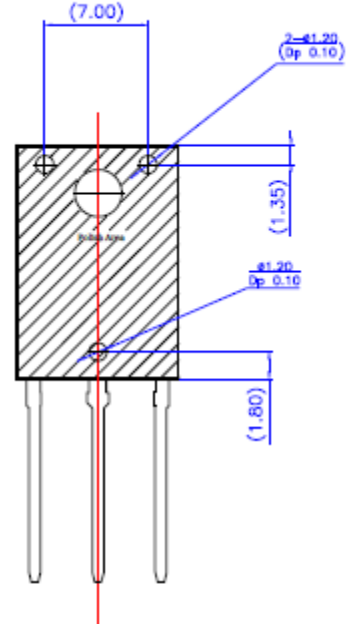

SIDE VIEW

