

HCS70R420ST

700V N-Channel Super Junction MOSFET

Features

- Very Low FOM ($R_{DS(on)} \times Q_g$)
- Extremely low switching loss
- Excellent stability and uniformity
- 100% Avalanche Tested
- Built-in ESD Diode

Application

- Switch Mode Power Supply (SMPS)
- Uninterruptible Power Supply (UPS)
- Power Factor Correction (PFC)
- TV power & LED Lighting Power
- AC to DC Converters
- Telecom

Key Parameters

Parameter	Value	Unit
$BV_{DSS} @ T_{j,max}$	750	V
I_D	9.9	A
$R_{DS(on), max}$	0.42	Ω
Q_g, Typ	22.6	nC

Package & Internal Circuit

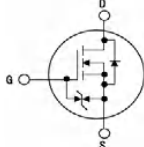
TO-220FT	SYMBOL
	

Absolute Maximum Ratings $T_C=25^\circ\text{C}$ unless otherwise specified

Symbol	Parameter	Value	Unit
V_{DSS}	Drain-Source Voltage	700	V
V_{GS}	Gate-Source Voltage	± 20	V
I_D	Drain Current - Continuous ($T_C = 25^\circ\text{C}$)	9.9 *	A
	Drain Current - Continuous ($T_C = 100^\circ\text{C}$)	6.3 *	A
$I_{DM}^{1)}$	Drain Current - Pulsed	30.0 *	A
$E_{AS}^{2)}$	Single Pulsed Avalanche Energy	117	mJ
I_{AR}	Avalanche Current	1.65	A
dv/dt	MOSFET dv/dt ruggedness, $V_{DS}=0 \dots 400\text{V}$	50	V/ns
dv/dt	Reverse diode dv/dt, $V_{DS}=0 \dots 400\text{V}$, $I_{DS} \leq I_D$	15	V/ns
P_D	Power Dissipation ($T_C = 25^\circ\text{C}$)	30	W
$V_{ESD(G-S)}$	Gate source ESD(HBM-C=100pF, R=1.5K Ω)	2000	V
T_J, T_{STG}	Operating and Storage Temperature Range	-55 to +150	$^\circ\text{C}$

* Drain current limited by maximum junction temperature

Thermal Resistance Characteristics

Symbol	Parameter	Value	Unit
$R_{\theta JC}$	Thermal Resistance, Junction-to-Case, Max.	4.1	$^\circ\text{C/W}$
$R_{\theta JA}$	Thermal Resistance, Junction-to-Ambient, Max.	80	$^\circ\text{C/W}$

Electrical Characteristics $T_J=25^\circ\text{C}$ unless otherwise specified

Symbol	Parameter	Test Conditions	Min	Typ	Max	Unit
On Characteristics						
V_{GS}	Gate Threshold Voltage	$V_{DS} = V_{GS}, I_D = 370 \mu\text{A}$	2.0	-	4.0	V
$R_{DS(ON)}$	Static Drain-Source On-Resistance	$V_{GS} = 10 \text{ V}, I_D = 3.1 \text{ A}$	-	0.365	0.42	Ω
Off Characteristics						
BV_{DSS}	Drain-Source Breakdown Voltage	$V_{GS} = 0 \text{ V}, I_D = 1 \text{ mA}$	700	-	-	V
I_{DSS}	Zero Gate Voltage Drain Current	$V_{DS} = 700 \text{ V}, V_{GS} = 0$	-	-	1	μA
		$V_{DS} = 700 \text{ V}, T_C = 150^\circ\text{C}$	-	-	100	μA
I_{GSS}	Gate-Body Leakage Current	$V_{GS} = \pm 20 \text{ V}, V_{DS} = 0 \text{ V}$	-	-	± 1	μA
Dynamic Characteristics						
C_{iss}	Input Capacitance	$V_{DS} = 400 \text{ V}, V_{GS} = 0 \text{ V},$ $f = 1.0 \text{ MHz}$	-	990	-	pF
C_{oss}	Output Capacitance		-	22	-	pF
C_{rss}	Reverse Transfer Capacitance		-	3.2	-	pF
Switching Characteristics						
$t_{d(on)}$	Turn-On Time	$V_{DS} = 350 \text{ V}, I_D = 4.8 \text{ A},$ $R_G = 25 \Omega$ (Note 3,4)	-	28	-	ns
t_r	Turn-On Rise Time		-	20	-	ns
$t_{d(off)}$	Turn-Off Delay Time		-	114	-	ns
t_f	Turn-Off Fall Time		-	17	-	ns
Q_{gt}	Total Gate Charge	$V_{DS} = 560 \text{ V}, I_D = 4.8 \text{ A},$ $V_{GS} = 10 \text{ V}$ (Note 3,4)	-	22.6	-	nC
Q_{gs}	Gate-Source Charge		-	4.6	-	nC
Q_{gd}	Gate-Drain Charge		-	6.4	-	nC
Drain-Source Diode Characteristics and Maximum Ratings						
I_S	Maximum Continuous Drain-Source Diode Forward Current		-	-	9.9	A
I_{SM}	Maximum Pulsed Drain-Source Diode Forward Current		-	-	30	A
V_{SD}	Drain-Source Diode Forward Voltage	$V_{GS} = 0 \text{ V}, I_S = 4.8 \text{ A}$	-	-	1.3	V
t_{rr}	Reverse Recovery Time	$V_R = 400 \text{ V}, I_F = 4.8 \text{ A}$ $di_F/dt = 100 \text{ A}/\mu\text{s}$	-	250	-	ns
Q_{rr}	Reverse Recovery Charge		-	2.6	-	μC

Notes :

1. Repetitive Rating : Pulse width limited by maximum junction temperature
2. $I_{AS}=1.65\text{A}, V_{DD}=50\text{V}, R_G=25\Omega,$ Starting $T_J=25^\circ\text{C}$
3. Pulse Test : Pulse Width $\leq 300\mu\text{s},$ Duty Cycle $\leq 2\%$
4. Essentially Independent of Operating Temperature

Typical Characteristics

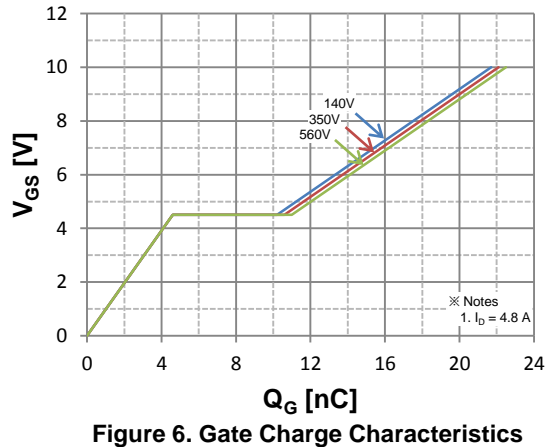
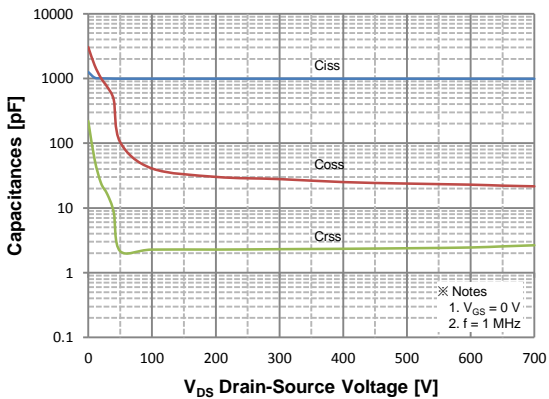
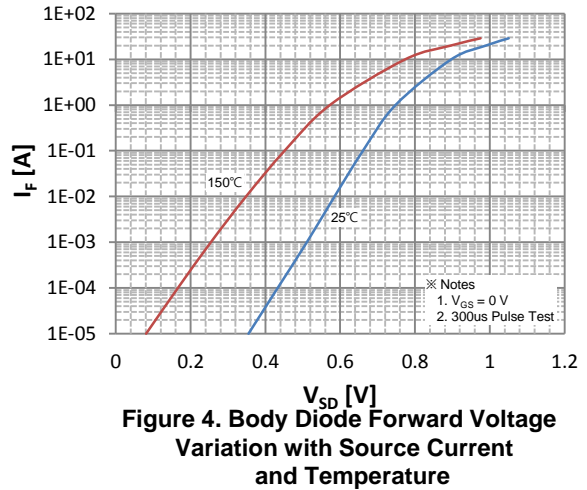
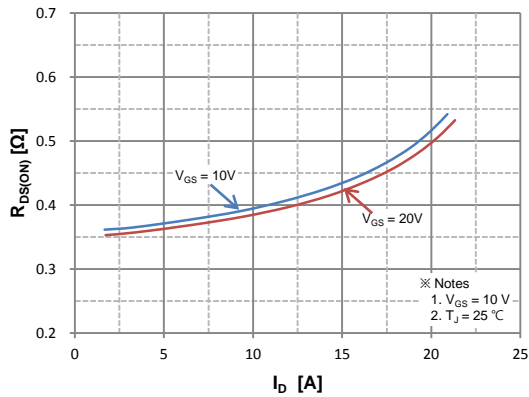
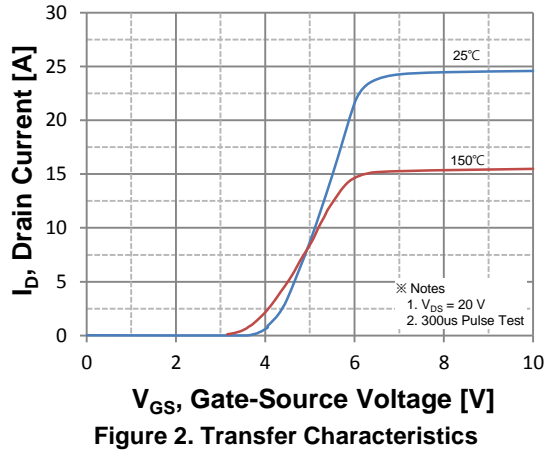
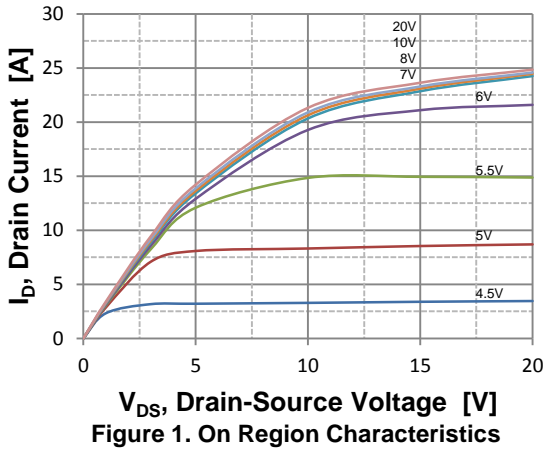

Typical Characteristics (continued)

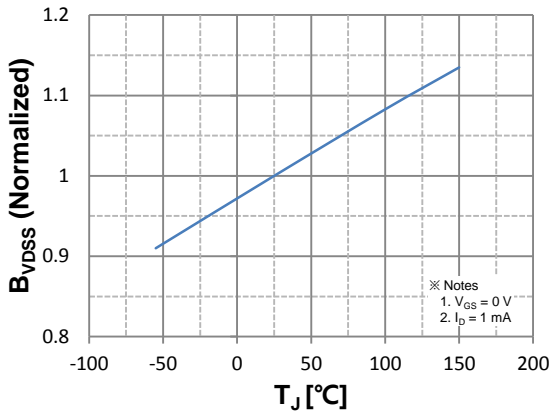

Figure 7. Breakdown Voltage Variation vs. Temperature

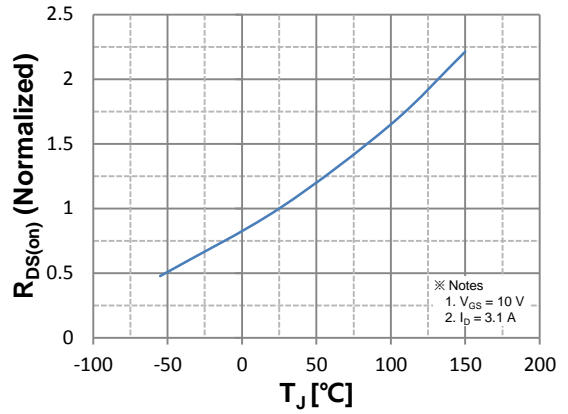

Figure 8. On-Resistance Variation vs. Temperature

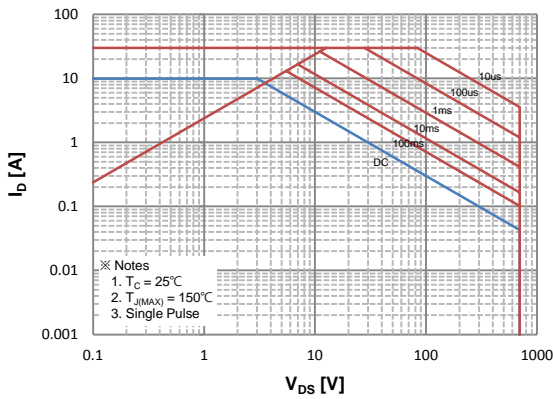

Figure 9. Maximum Safe Operating Area

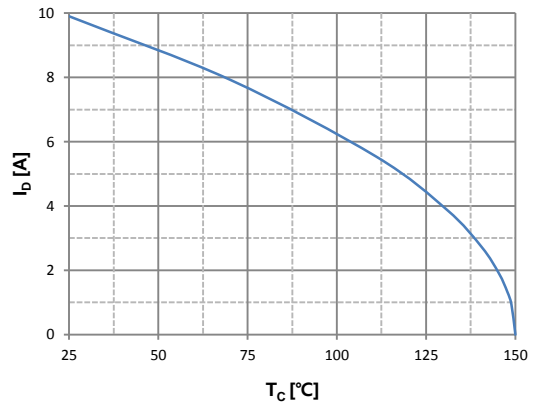

Figure 10. Maximum Drain Current vs. Case Temperature

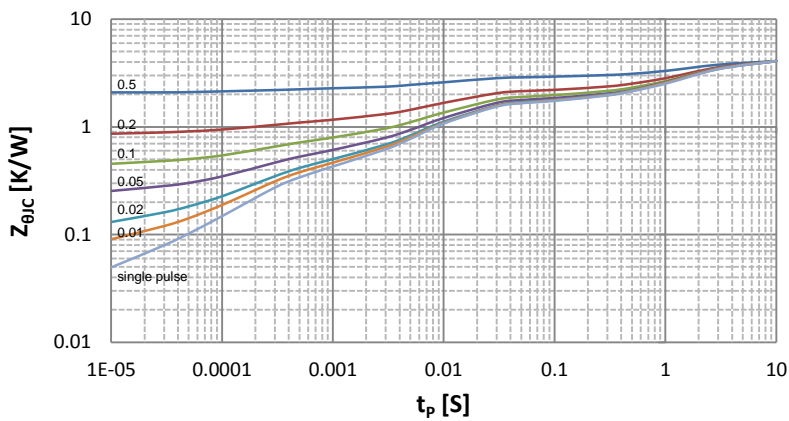

Figure 11. Transient Thermal Response Curve

Fig 12. Gate Charge Test Circuit & Waveform



Fig 13. Resistive Switching Test Circuit & Waveforms

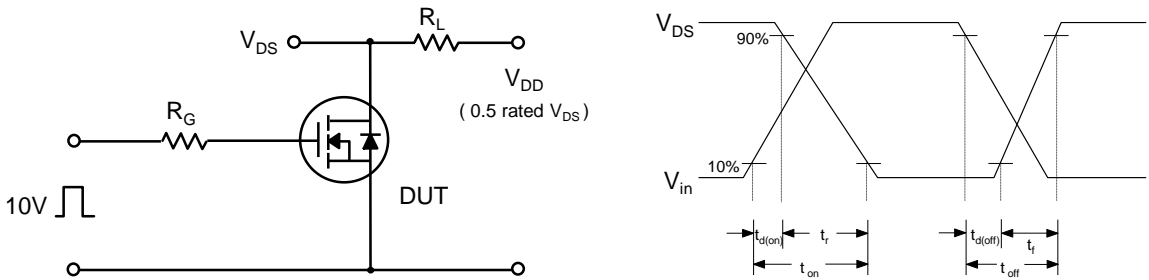

Fig 14. Unclamped Inductive Switching Test Circuit & Waveforms

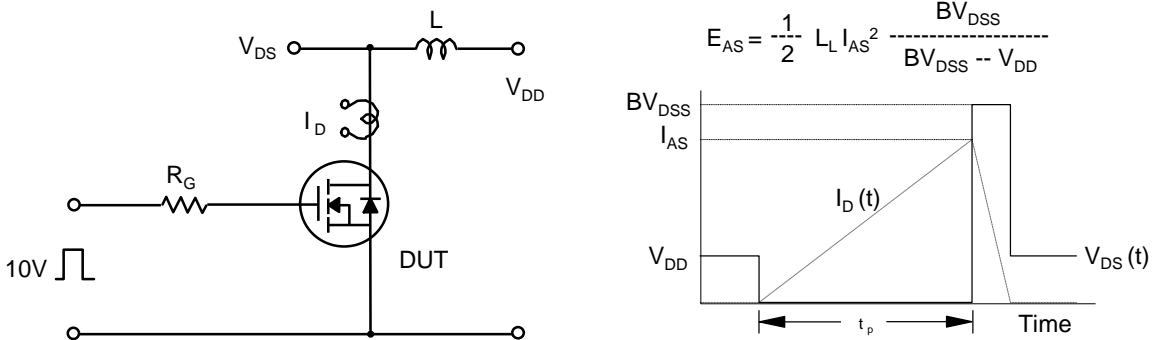

Fig 15. Peak Diode Recovery dv/dt Test Circuit & Waveforms



Package Dimension

TO-220FT

