



HRLE320N03K

30V N-Channel Trench MOSFET

Features

- Low Dense Cell Design
- Reliable and Rugged
- Advanced Trench Process Technology

Application

- Power Management in Inverter System
- Synchronous Rectification

Key Parameters

Parameter	Value	Unit
BV_{DSS}	30	V
I_D	5	A
$R_{DS(on)}$, typ @10V	27	m Ω
$R_{DS(on)}$, typ @4.5V	33	m Ω

Package & Internal Circuit

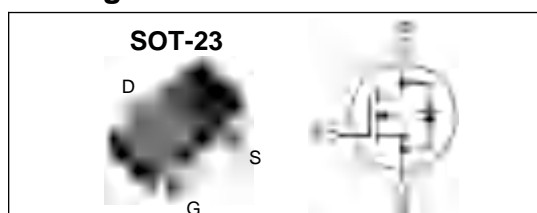

Absolute Maximum Ratings $T_A=25^\circ\text{C}$ unless otherwise specified

Symbol	Parameter	Value	Units
V_{DSS}	Drain-Source Voltage	30	V
V_{GS}	Gate-Source Voltage	± 20	V
I_D	Drain Current	$T_A = 25^\circ\text{C}$	5 A
		$T_A = 70^\circ\text{C}$	4 A
I_{DM}	Pulsed Drain Current	20	A
P_D	Power Dissipation	$T_A = 25^\circ\text{C}$	1.4 W
		$T_A = 70^\circ\text{C}$	0.9 W
T_J, T_{STG}	Operating and Storage Temperature Range	-55 to +150	$^\circ\text{C}$

Thermal Resistance Characteristics

Symbol	Parameter	Typ.	Max.	Units
$R_{\theta JA}$	Junction-to-Ambient ($t \leq 10\text{s}$)	--	90	$^\circ\text{C}/\text{W}$

Electrical Characteristics $T_J=25\text{ }^\circ\text{C}$ unless otherwise specified

Symbol	Parameter	Test Conditions	Min	Typ	Max	Units
On Characteristics						
V_{GS}	Gate Threshold Voltage	$V_{DS} = V_{GS}, I_D = 250\ \mu\text{A}$	1.0	--	3.0	V
$R_{DS(ON)}$	Static Drain-Source On-Resistance	$V_{GS} = 10\ \text{V}, I_D = 5\ \text{A}$	--	27	32	m Ω
		$V_{GS} = 4.5\ \text{V}, I_D = 4\ \text{A}$	--	33	40	m Ω
g_{FS}	Forward Transconductance	$V_{DS} = 5\ \text{V}, I_D = 5\ \text{A}$	--	15	--	S
Off Characteristics						
BV_{DSS}	Drain-Source Breakdown Voltage	$V_{GS} = 0\ \text{V}, I_D = 250\ \mu\text{A}$	30	--	--	V
I_{DSS}	Zero Gate Voltage Drain Current	$V_{DS} = 24\ \text{V}, V_{GS} = 0\ \text{V}$	--	--	1	μA
		$V_{DS} = 24\ \text{V}, T_J = 55\text{ }^\circ\text{C}$	--	--	5	μA
I_{GSS}	Gate-Body Leakage Current	$V_{GS} = \pm 20\ \text{V}, V_{DS} = 0\ \text{V}$	--	--	± 100	nA
Dynamic Characteristics						
C_{iss}	Input Capacitance	$V_{DS} = 15\ \text{V}, V_{GS} = 0\ \text{V},$ $f = 1.0\ \text{MHz}$	--	450	--	pF
C_{oss}	Output Capacitance		--	62	--	pF
C_{riss}	Reverse Transfer Capacitance		--	50	--	pF
R_g	Gate Resistance	$V_{GS} = 0\ \text{V}, V_{DS} = 0\ \text{V}, f = 1\ \text{MHz}$	--	2.5	--	Ω
Switching Characteristics						
$t_{d(on)}$	Turn-On Time	$V_{DS} = 15\ \text{V}, I_D = 5\ \text{A},$ $R_G = 6\ \Omega$	--	15	--	ns
t_r	Turn-On Rise Time		--	9	--	ns
$t_{d(off)}$	Turn-Off Delay Time		--	31	--	ns
t_f	Turn-Off Fall Time		--	12	--	ns
$Q_{g(10V)}$	Total Gate Charge	$V_{DS} = 15\ \text{V}, I_D = 5\ \text{A},$ $V_{GS} = 10\ \text{V}$	--	8.5	11	nC
$Q_{g(4.5V)}$			--	4.0	5.2	nC
Q_{gs}	Gate-Source Charge		--	1.0	--	nC
Q_{gd}	Gate-Drain Charge		--	1.5	--	nC
Source-Drain Diode Maximum Ratings and Characteristics						
I_S	Continuous Source-Drain Diode Forward Current		--	--	5	A
I_{SM}	Pulsed Source-Drain Diode Forward Current		--	--	20	
V_{SD}	Source-Drain Diode Forward Voltage	$I_S = 3\ \text{A}, V_{GS} = 0\ \text{V}$	--	--	1.3	V
t_{rr}	Reverse Recovery Time	$I_S = 5\ \text{A}, V_{GS} = 0\ \text{V}$ $di_F/dt = 100\ \text{A}/\mu\text{s}$	--	10	--	ns
Q_{rr}	Reverse Recovery Charge		--	2.5	--	nC

Typical Characteristics

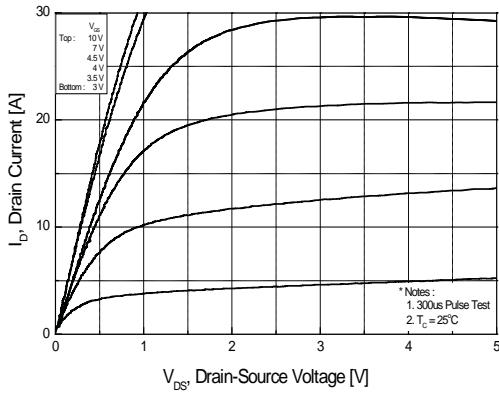

Figure 1. On Region Characteristics

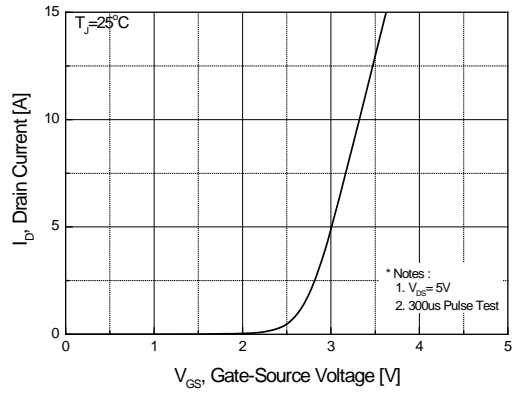

Figure 2. Transfer Characteristics

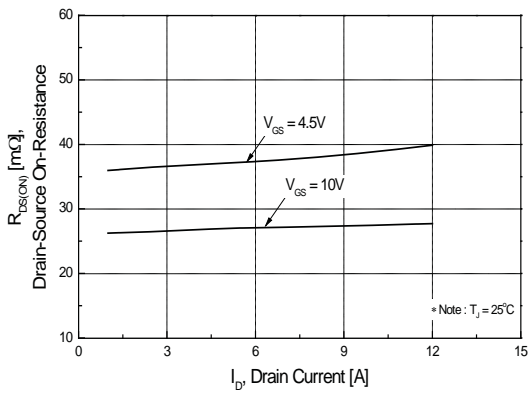

Figure 3. On Resistance Variation vs Drain Current and Gate Voltage

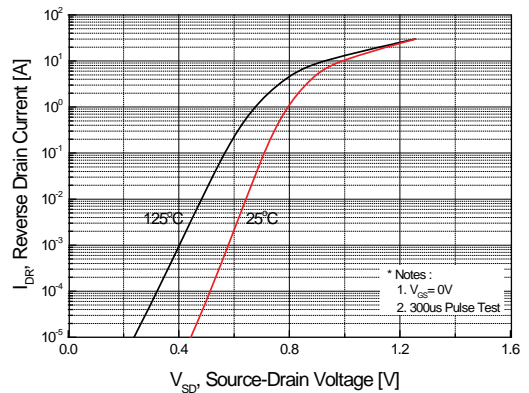

Figure 4. Body Diode Forward Voltage Variation with Source Current and Temperature

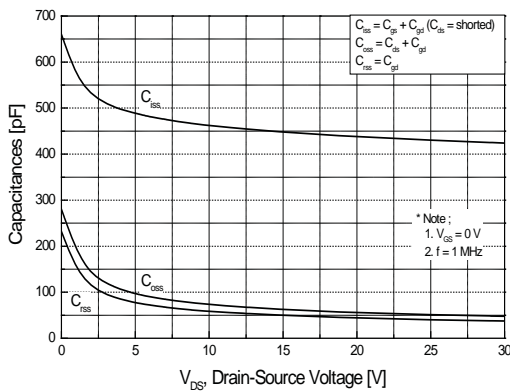

Figure 5. Capacitance Characteristics

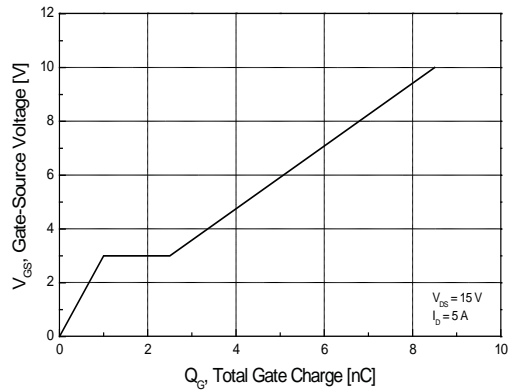

Figure 6. Gate Charge Characteristics

Typical Characteristics (continued)

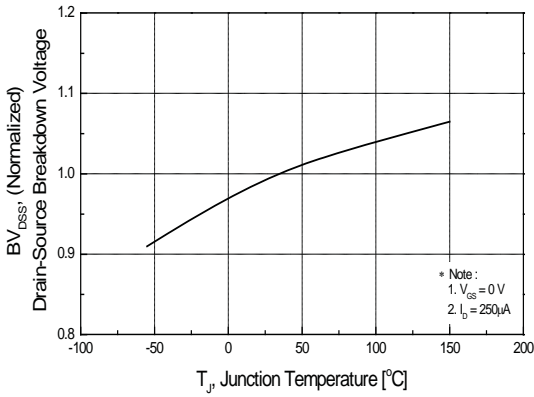

Figure 7. Breakdown Voltage Variation vs Temperature

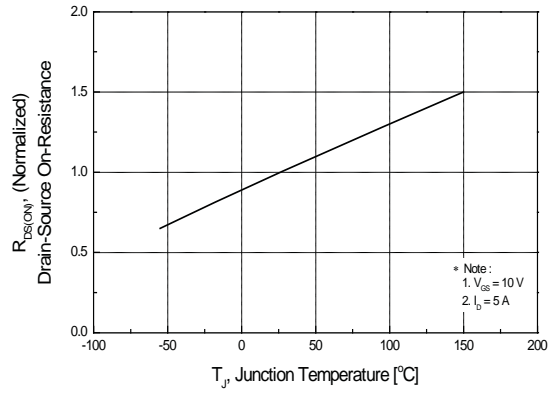

Figure 8. On-Resistance Variation vs Temperature

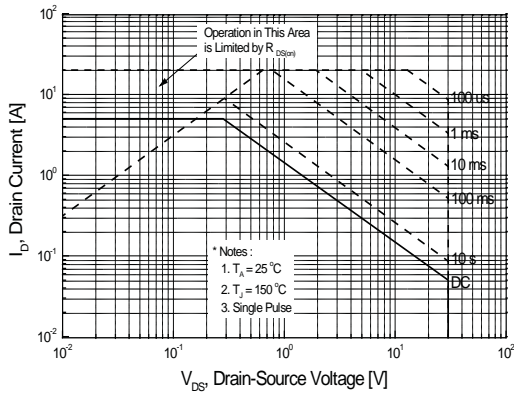

Figure 9. Maximum Safe Operating Area

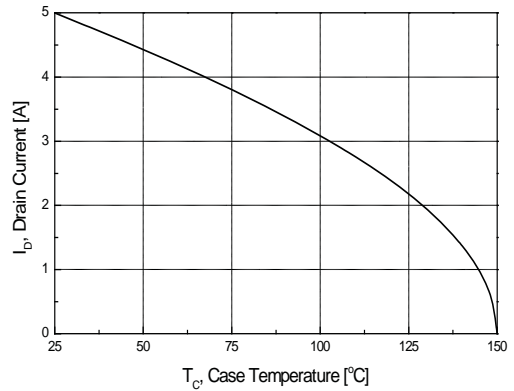

Figure 10. Maximum Drain Current vs Case Temperature

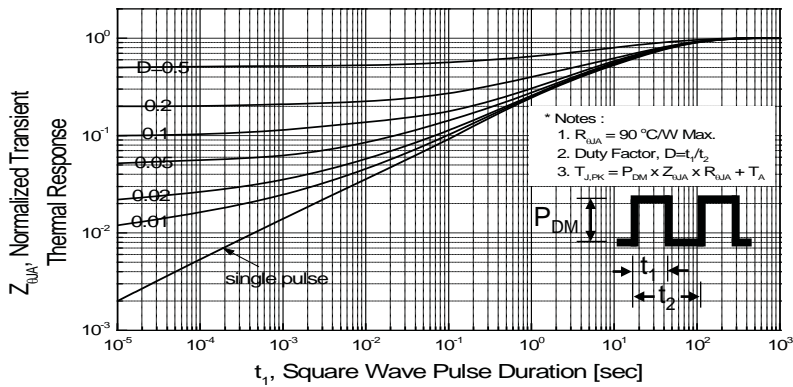

Figure 11. Transient Thermal Response Curve

Fig 12. Gate Charge Test Circuit & Waveform



Fig 13. Resistive Switching Test Circuit & Waveforms



Fig 14. Unclamped Inductive Switching Test Circuit & Waveforms

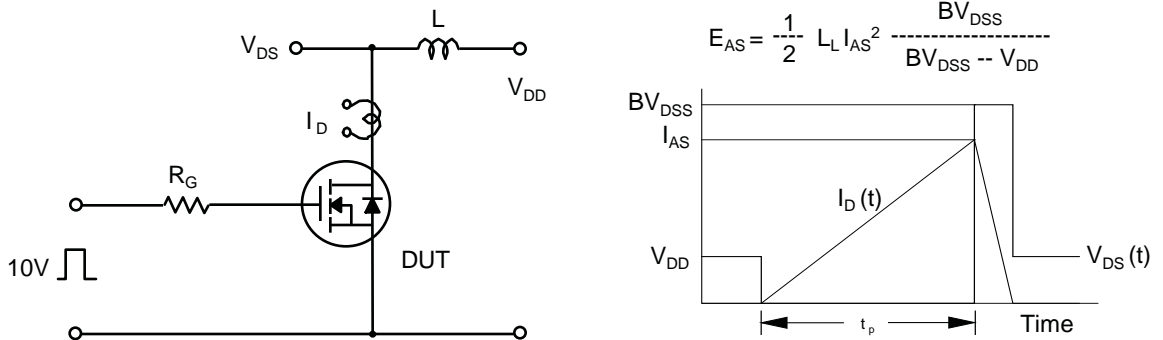
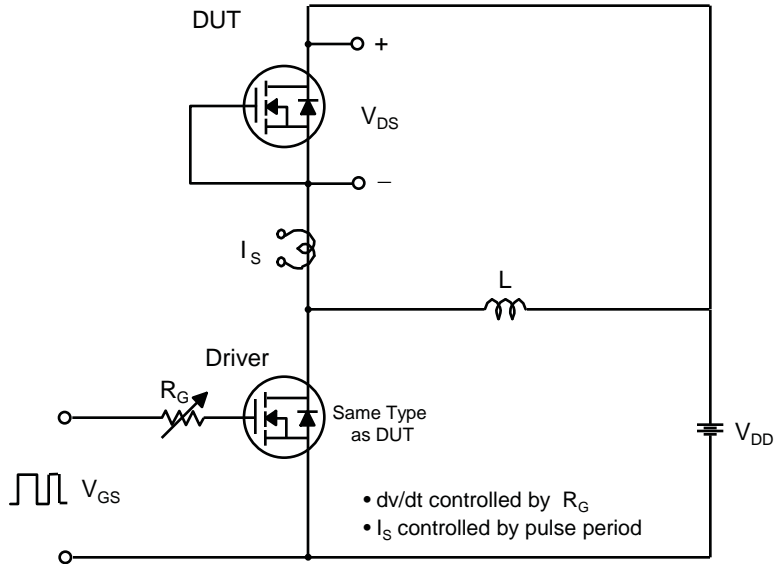
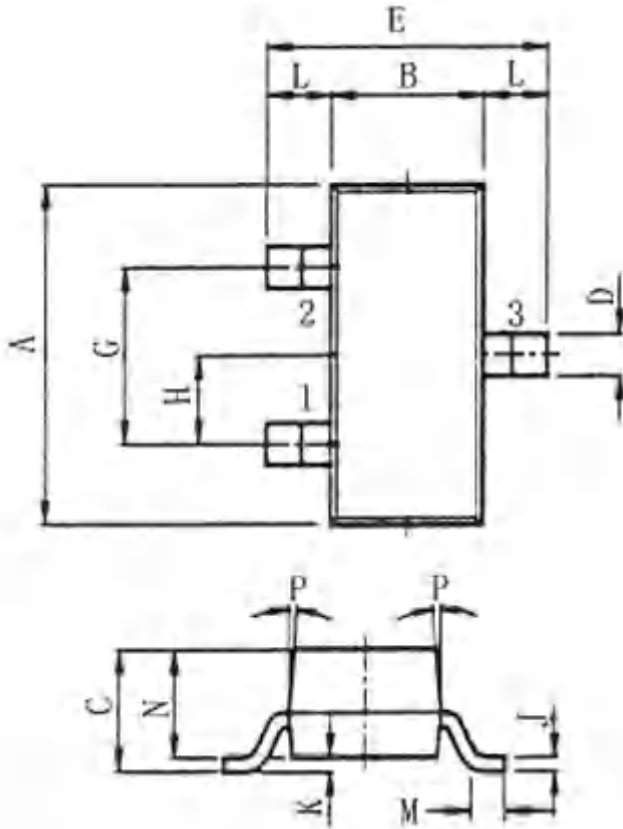

Fig 15. Peak Diode Recovery dv/dt Test Circuit & Waveforms



Package Dimension & Marking Information

SOT-23



A	2.90±0.20
B	1.30+0.20/-0.15
C	1.30MAX
D	0.40+0.15/-0.05
E	2.40+0.30/-0.20
G	1.90±0.2
H	0.95±0.1
J	0.10+0.10/-0.05
K	0.00~0.10
L	0.55±0.1
M	0.20MIN
N	1.00+0.20/-0.10
P	7°