

AP25P06K

P-Channel Power MOSFET

Description

The AP25P06K uses advanced trench technology and design to provide excellent $R_{DS(ON)}$ with low gate charge. This device is well suited for high current load applications.

General Features

- $V_{DS} = -60V, I_D = -25A$
 $R_{DS(ON)} < 60m\Omega @ V_{GS} = -10V$
 $R_{DS(ON)} < 72m\Omega @ V_{GS} = -4.5V$
- High density cell design for ultra low $R_{ds(on)}$
- Fully characterized avalanche voltage and current
- Good stability and uniformity with high E_{AS}
- Excellent package for good heat dissipation

Application

- High side switch for full bridge converter
- DC/DC converter for LCD display

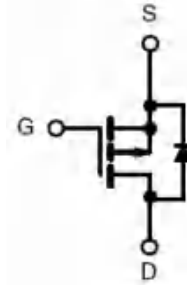

Schematic diagram

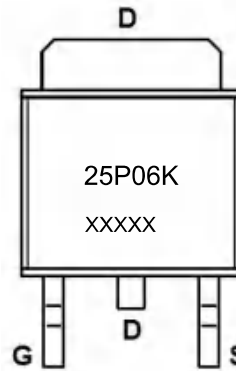

Marking and pin assignment



TO-252 -2L top view

Package Marking and Ordering Information

Device Marking	Device	Device Package	Reel Size	Tape width	Quantity
25P06K	AP25P06K	TO-252			

Absolute Maximum Ratings ($T_C = 25^\circ C$ unless otherwise noted)

Parameter	Symbol	Limit	Unit
Drain-Source Voltage	V_{DS}	-60	V
Gate-Source Voltage	V_{GS}	± 20	V
Drain Current-Continuous	I_D	-25	A
Drain Current-Continuous($T_C = 100^\circ C$)	$I_D(100^\circ C)$	-12.7	A
Pulsed Drain Current	I_{DM}	-72	A
Maximum Power Dissipation	P_D	60	W
Derating factor		0.4	W/ $^\circ C$
Single pulse avalanche energy (Note 5)	E_{AS}	50	mJ
Operating Junction and Storage Temperature Range	T_J, T_{STG}	-55 To 175	$^\circ C$

Thermal Characteristic

Thermal Resistance, Junction-to-Case (Note 2)	$R_{\theta JC}$	2.5	$^\circ C/W$
---	-----------------	-----	--------------

AP25P06K
P-Channel Power MOSFET
Electrical Characteristics (T_C=25°C unless otherwise noted)

Parameter	Symbol	Condition	Min	Typ	Max	Unit
Off Characteristics						
Drain-Source Breakdown Voltage	BV _{DSS}	V _{GS} =0V, I _D =-250μA	-60	-	-	V
Zero Gate Voltage Drain Current	I _{DSS}	V _{DS} =-60V, V _{GS} =0V	-	-	-1	μA
Gate-Body Leakage Current	I _{GSS}	V _{GS} =±20V, V _{DS} =0V	-	-	±100	nA
On Characteristics (Note 3)						
Gate Threshold Voltage	V _{GS(th)}	V _{DS} =V _{GS} , I _D =-250μA	-1	-1.6	-2.2	V
Drain-Source On-State Resistance	R _{DS(on)}	V _{GS} =-10V, I _D =-12A	-	49	60	mΩ
		V _{GS} =-4.5V, I _D =-8A	-	58	72	mΩ
Forward Transconductance	g _{FS}	V _{DS} =-5V, I _D =-12A	-	10	-	S
Dynamic Characteristics (Note4)						
Input Capacitance	C _{iss}	V _{DS} =-30V, V _{GS} =0V, F=1.0MHz	-	1630.7	-	PF
Output Capacitance	C _{oss}		-	90.6	-	PF
Reverse Transfer Capacitance	C _{rss}		-	77.3	-	PF
Switching Characteristics (Note 4)						
Turn-on Delay Time	t _{d(on)}	V _{DD} =-30V, R _L =1.5Ω, V _{GS} =-10V, R _G =3Ω	-	11	-	nS
Turn-on Rise Time	t _r		-	14	-	nS
Turn-Off Delay Time	t _{d(off)}		-	33	-	nS
Turn-Off Fall Time	t _f		-	13	-	nS
Total Gate Charge	Q _g	V _{DS} =-30, I _D =-12A, V _{GS} =-10V	-	37.6	-	nC
Gate-Source Charge	Q _{gs}		-	4.3	-	nC
Gate-Drain Charge	Q _{gd}		-	7.2	-	nC
Drain-Source Diode Characteristics						
Diode Forward Voltage (Note 3)	V _{SD}	V _{GS} =0V, I _S =-12A	-	-	-1.2	V
Diode Forward Current (Note 2)	I _S		-	-	-25	A
Reverse Recovery Time	t _{rr}	T _J = 25°C, I _F = -12A	-	35	-	nS
Reverse Recovery Charge	Q _{rr}	di/dt = -100A/μs (Note3)	-	38	-	nC
Forward Turn-On Time	t _{on}	Intrinsic turn-on time is negligible (turn-on is dominated by LS+LD)				

Notes:

1. Repetitive Rating: Pulse width limited by maximum junction temperature.
2. Surface Mounted on FR4 Board, t ≤ 10 sec.
3. Pulse Test: Pulse Width ≤ 300μs, Duty Cycle ≤ 2%.
4. Guaranteed by design, not subject to production
5. E_{AS} condition: T_J=25°C, V_{DD}=-30V, V_G=-10V, L=0.5mH, R_G=25Ω

AP25P06K

P-Channel Power MOSFET

Test Circuit

1) E_{AS} Test Circuit

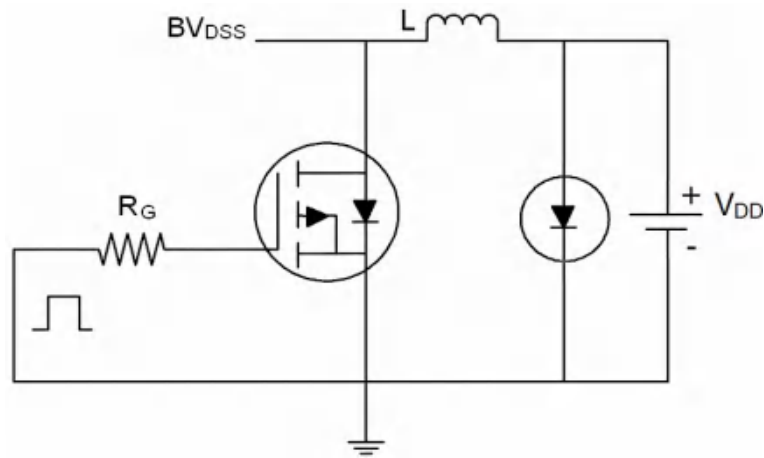

2) Gate Charge Test Circuit

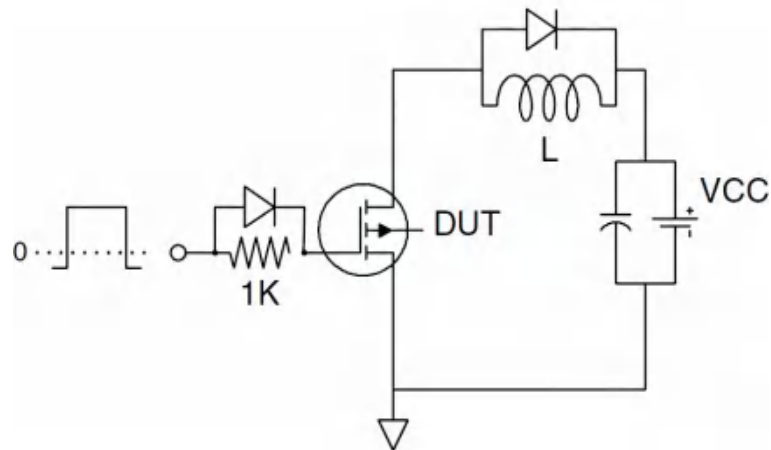

3) Switch Time Test Circuit

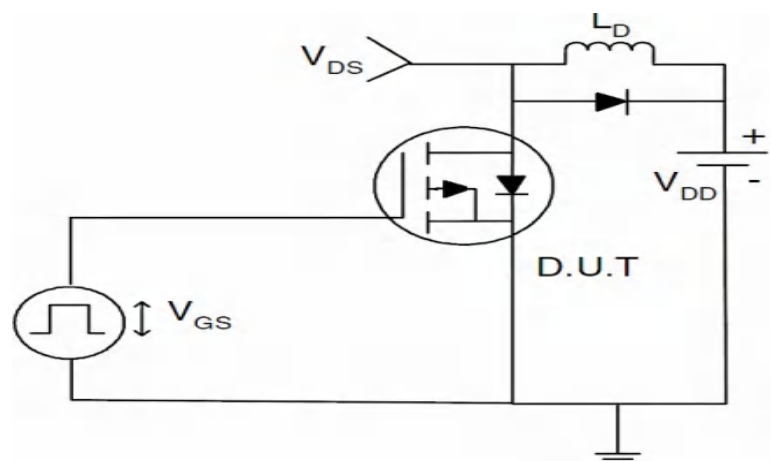

AP25P06K

P-Channel Power MOSFET

Typical Electrical and Thermal Characteristics (Curves)

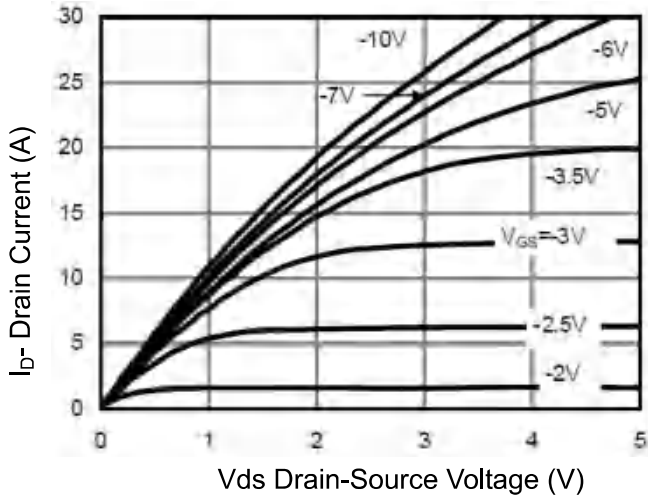

Figure 1 Output Characteristics

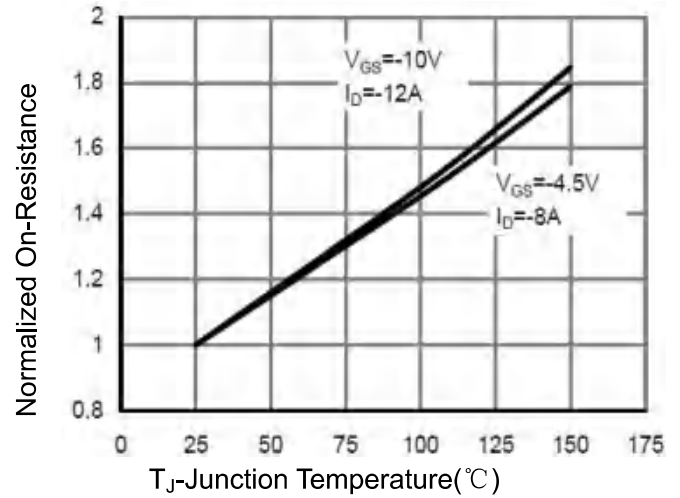

Figure 4 R_{dson} -Junction Temperature

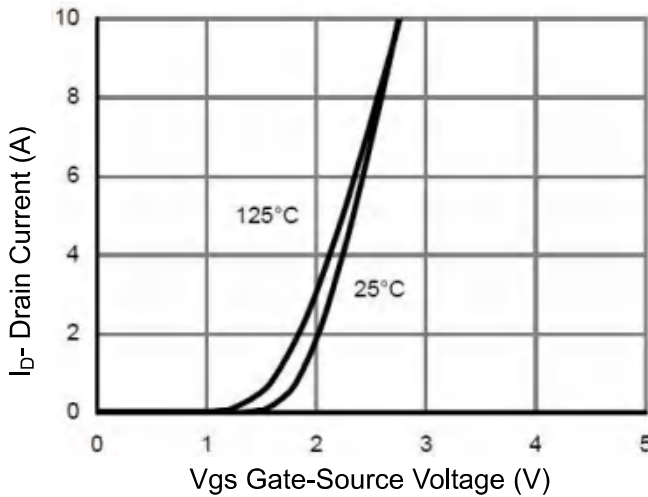

Figure 2 Transfer Characteristics

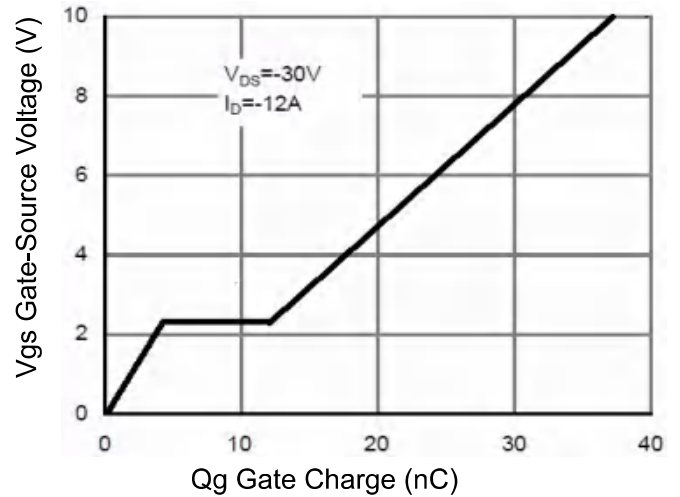

Figure 5 Gate Charge

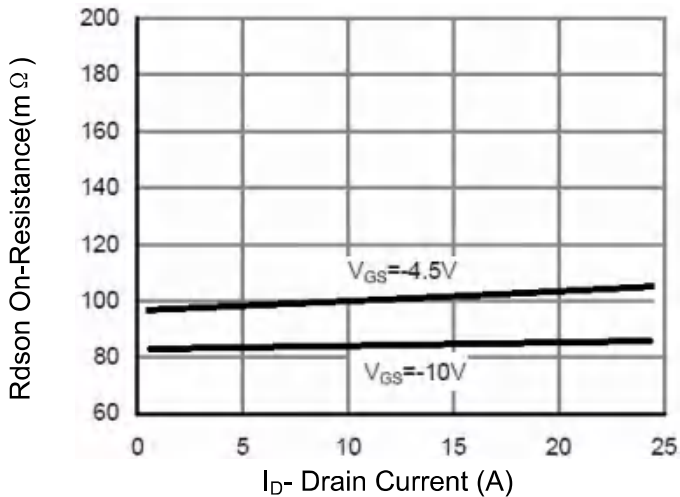

Figure 3 R_{dson} - Drain Current

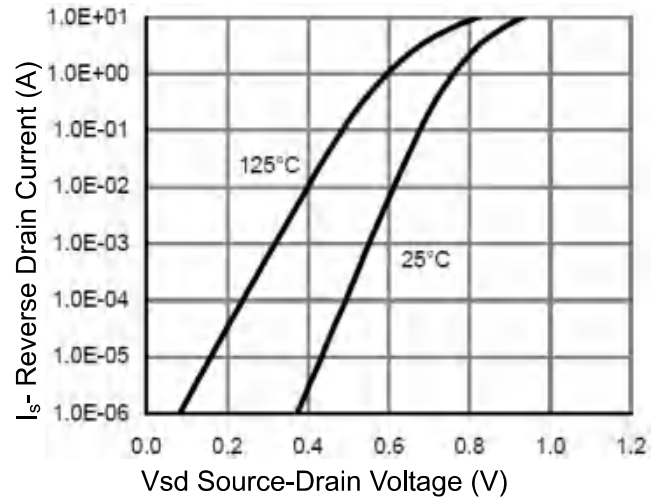

Figure 6 Source- Drain Diode Forward

AP25P06K

P-Channel Power MOSFET

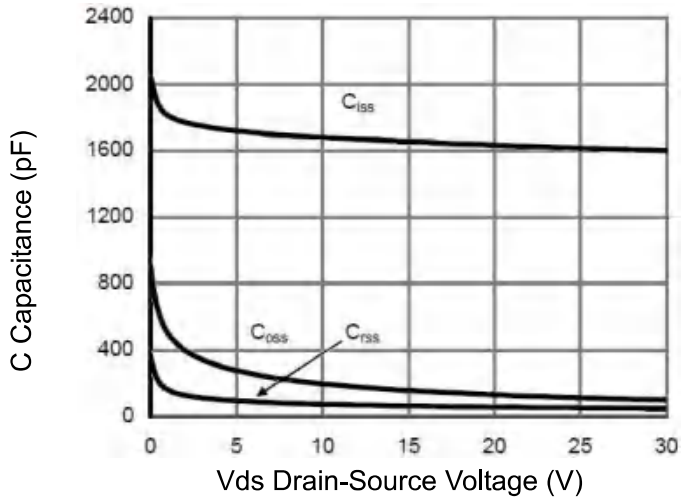

Figure 7 Capacitance vs Vds

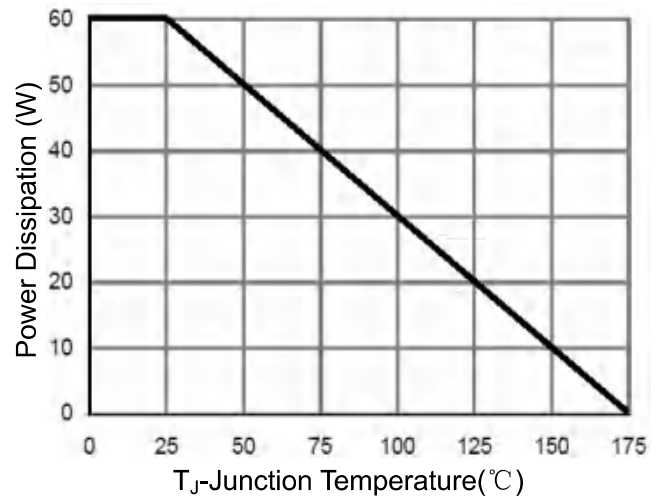

Figure 9 Power De-rating

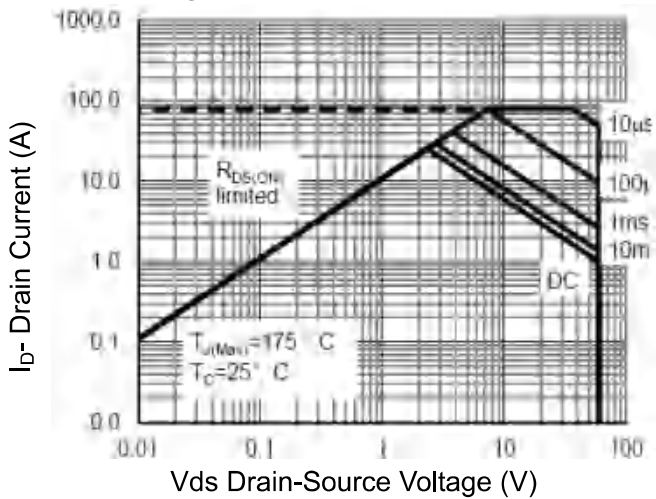

Figure 8 Safe Operation Area

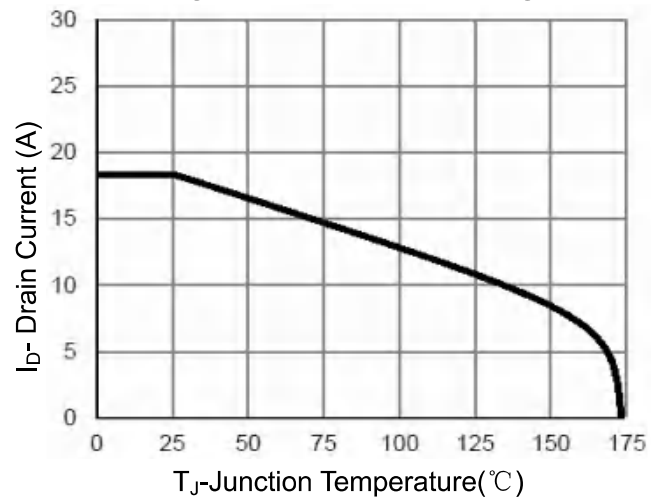

Figure 10 ID Current De-rating

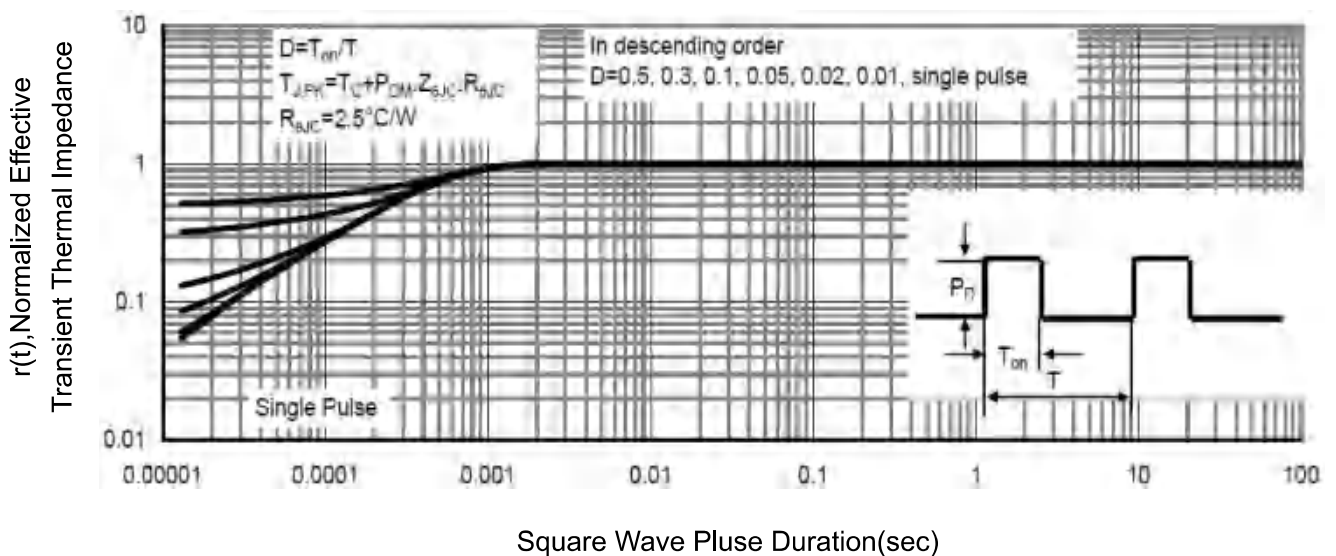

Figure 11 Normalized Maximum Transient Thermal Impedance

