



## Description

### JMT N Enhancement Mode Power MOSFET

#### Features

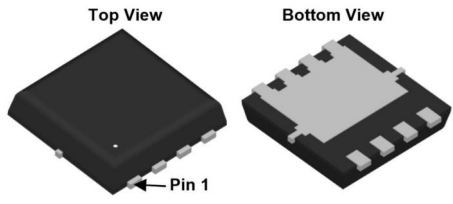
- 30V,12A  
 $R_{DS(ON)} < 20m\Omega @ V_{GS} = 10V$   
 $R_{DS(ON)} < 29m\Omega @ V_{GS} = 4.5V$
- Advanced Trench Technology
- Provide Excellent  $R_{DS(ON)}$  and Low Gate Charge
- Lead free product is acquired

#### Application

- Battery Protection
- Load Switch
- Power Management

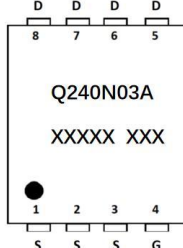


*100% UIS TESTED!*  
*100% ΔVds TESTED!*



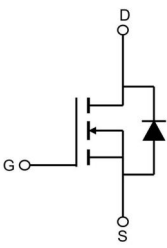
Top View      Bottom View

PDFN3x3-8L



Q240N03A  
XXXXX XXX

Marking and pin Assignment



Schematic Diagram

## Package Marking and Ordering Information

Device Marking	Device	OUTLINE	Device Package	Reel Size	Reel (PCS)	Per Carton (PCS)
Q240N03A	JMTQ240N03A	TAPING	PDFN3x3-8L	13inch	5000	50000

## Absolute Maximum Ratings (T<sub>A</sub>=25°C unless otherwise specified)

Symbol	Parameter	Max.	Units
V <sub>DSS</sub>	Drain-Source Voltage	30	V
V <sub>GSS</sub>	Gate-Source Voltage	±20	V
I <sub>D</sub>	Continuous Drain Current	T <sub>C</sub> = 25°C	12
		T <sub>C</sub> = 100°C	7.8
I <sub>DM</sub>	Pulsed Drain Current <sup>note1</sup>	48	A
E <sub>AS</sub>	Single Pulsed Avalanche Energy <sup>note2</sup>	11	mJ
P <sub>D</sub>	Power Dissipation	T <sub>C</sub> = 25°C	4.8
R <sub>θJC</sub>	Thermal Resistance, Junction to Case	26	°C/W
T <sub>J</sub> , T <sub>STG</sub>	Operating and Storage Temperature Range	-55 to +150	°C



## Electrical Characteristics (T<sub>J</sub>=25°C unless otherwise specified)

Symbol	Parameter	Test Condition	Min.	Typ.	Max.	Units
<b>Off Characteristic</b>						
V <sub>(BR)DSS</sub>	Drain-Source Breakdown Voltage	V <sub>GS</sub> =0V, I <sub>D</sub> =250μA	30	-	-	V
I <sub>DSS</sub>	Zero Gate Voltage Drain Current	V <sub>DS</sub> =30V, V <sub>GS</sub> =0V	-	-	1	μA
I <sub>GSS</sub>	Gate to Body Leakage Current	V <sub>DS</sub> =0V, V <sub>GS</sub> =±20V	-	-	±100	nA
<b>On Characteristics</b>						
V <sub>GS(th)</sub>	Gate Threshold Voltage	V <sub>DS</sub> =V <sub>GS</sub> , I <sub>D</sub> =250μA	1.0	1.5	2.5	V
R <sub>DS(on)</sub>	Static Drain-Source on-Resistance <small>note2</small>	V <sub>GS</sub> =10V, I <sub>D</sub> =5A	-	15	20	mΩ
		V <sub>GS</sub> =4.5V, I <sub>D</sub> =3A	-	21	29	mΩ
<b>Dynamic Characteristics</b>						
C <sub>iss</sub>	Input Capacitance	V <sub>DS</sub> =15V, V <sub>GS</sub> =0V, f=1.0MHz	-	490	-	pF
C <sub>oss</sub>	Output Capacitance		-	79	-	pF
C <sub>rss</sub>	Reverse Transfer Capacitance		-	61	-	pF
Q <sub>g</sub>	Total Gate Charge	V <sub>DS</sub> =15V, I <sub>D</sub> =5.8A, V <sub>GS</sub> =10V	-	5.2	-	nC
Q <sub>gs</sub>	Gate-Source Charge		-	0.9	-	nC
Q <sub>gd</sub>	Gate-Drain("Miller") Charge		-	1.3	-	nC
<b>Switching Characteristics</b>						
t <sub>d(on)</sub>	Turn-on Delay Time	V <sub>DS</sub> =15V, I <sub>D</sub> =3A, V <sub>GS</sub> =10V, R <sub>REN</sub> =3Ω	-	4.5	-	ns
t <sub>r</sub>	Turn-on Rise Time		-	2.5	-	ns
t <sub>d(off)</sub>	Turn-off Delay Time		-	14.5	-	ns
t <sub>f</sub>	Turn-off Fall Time		-	3.5	-	ns
<b>Drain-Source Diode Characteristics and Maximum Ratings</b>						
I <sub>S</sub>	Maximum Continuous Drain to Source Diode Forward Current		-	-	12	A
I <sub>SM</sub>	Maximum Pulsed Drain to Source Diode Forward Current		-	-	48	A
V <sub>SD</sub>	Drain to Source Diode Forward Voltage	V <sub>GS</sub> =0V, I <sub>S</sub> = 12A	-	-	1.2	V

Notes:1. Repetitive Rating: Pulse Width Limited by Maximum Junction Temperature

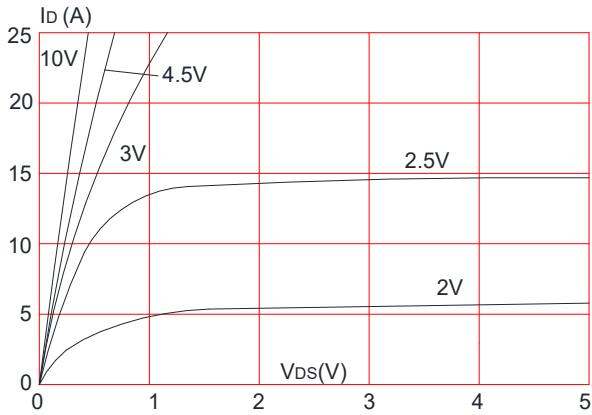
2. EAS condition : T<sub>J</sub>=25°C, V<sub>DD</sub>=15V, V<sub>G</sub>=10V, L=0.5mH, R<sub>g</sub>=25Ω, I<sub>AS</sub>=6.6A

3. Pulse Test: Pulse Width≤300μs, Duty Cycle≤0.5%

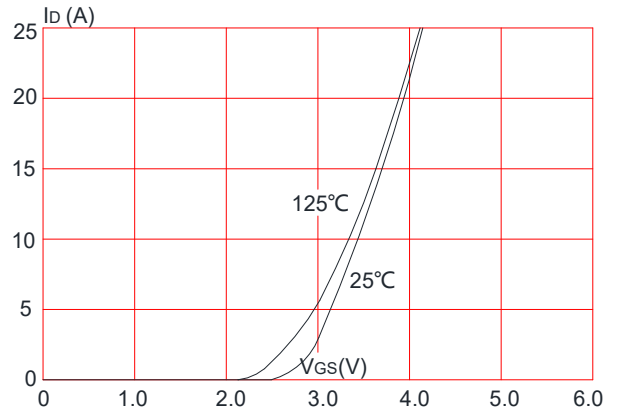


## Typical Performance Characteristics

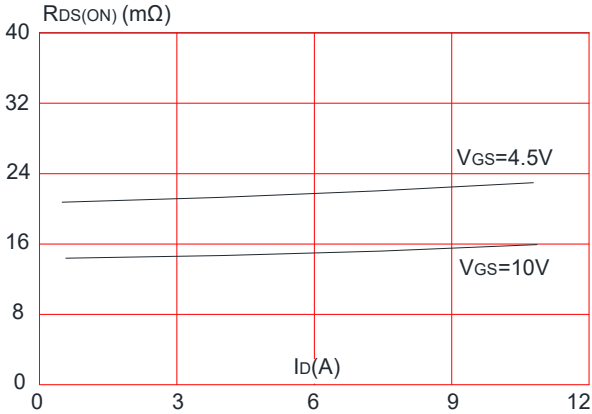
**Figure 1: Output Characteristics**



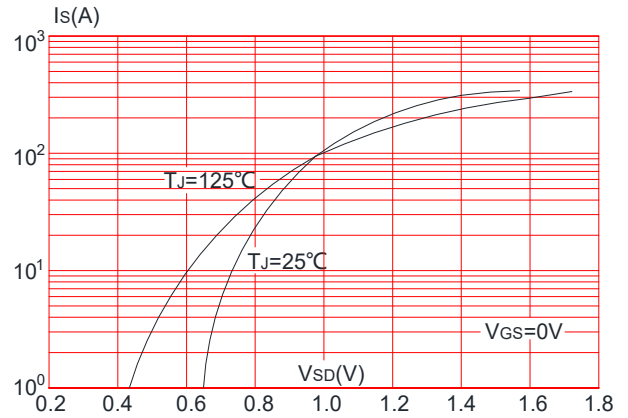
**Figure 2: Typical Transfer Characteristics**



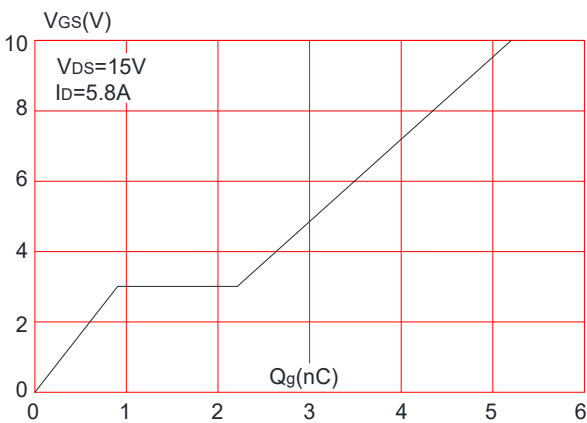
**Figure 3: On-resistance vs. Drain Current**



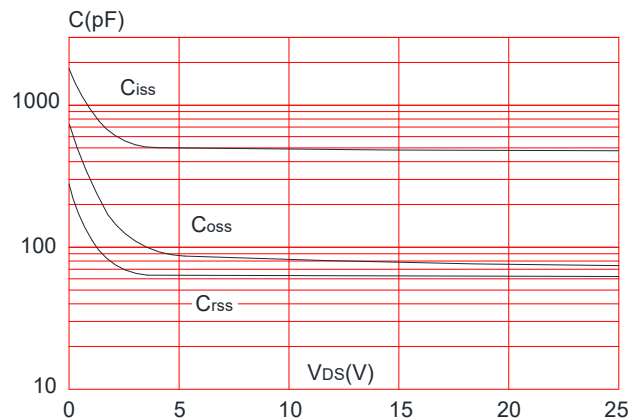
**Figure 4: Body Diode Characteristics**



**Figure 5: Gate Charge Characteristics**

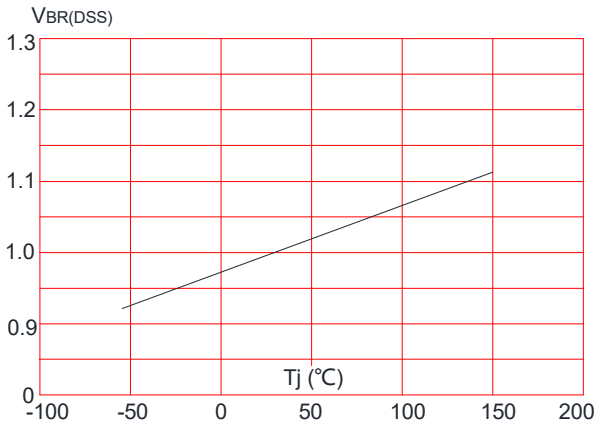


**Figure 6: Capacitance Characteristics**

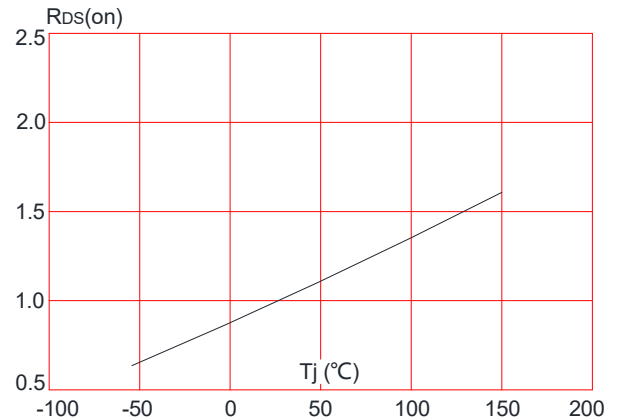




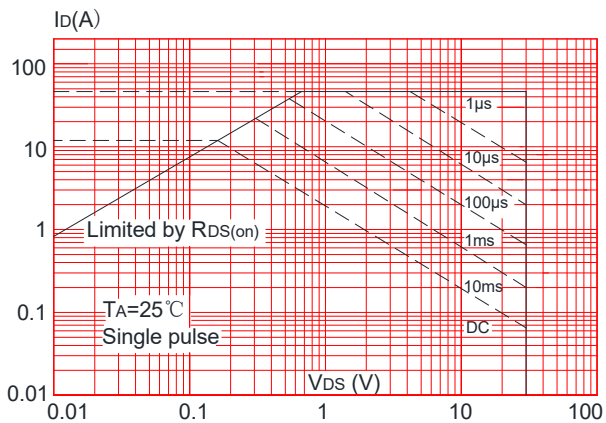
**Figure 7: Normalized Breakdown Voltage vs. Junction Temperature**



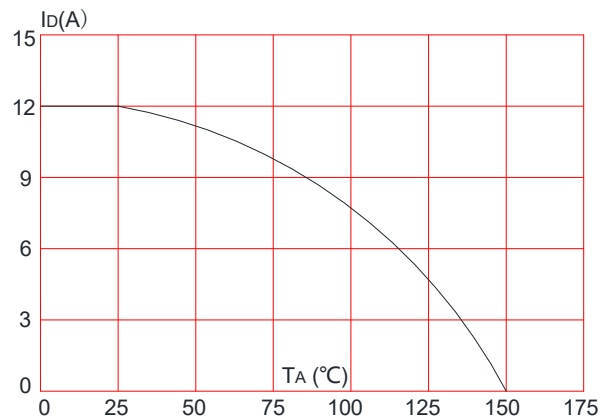
**Figure 8: Normalized on Resistance vs. Junction Temperature**



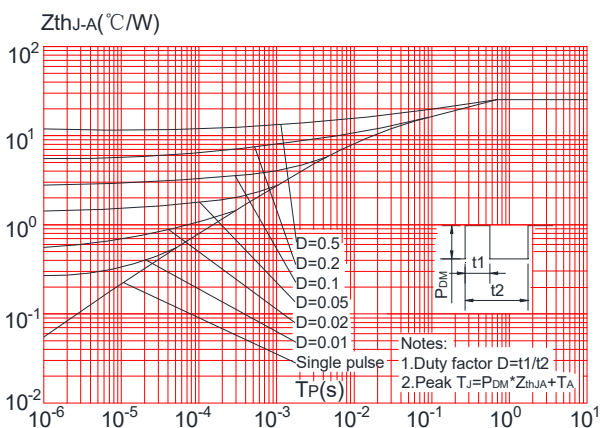
**Figure 9: Maximum Safe Operating Area**



**Figure 10: Maximum Continuous Drain Current vs. Ambient Temperature**



**Figure.11: Maximum Effective Transient Thermal Impedance, Junction-to-Ambient**



## Test Circuit

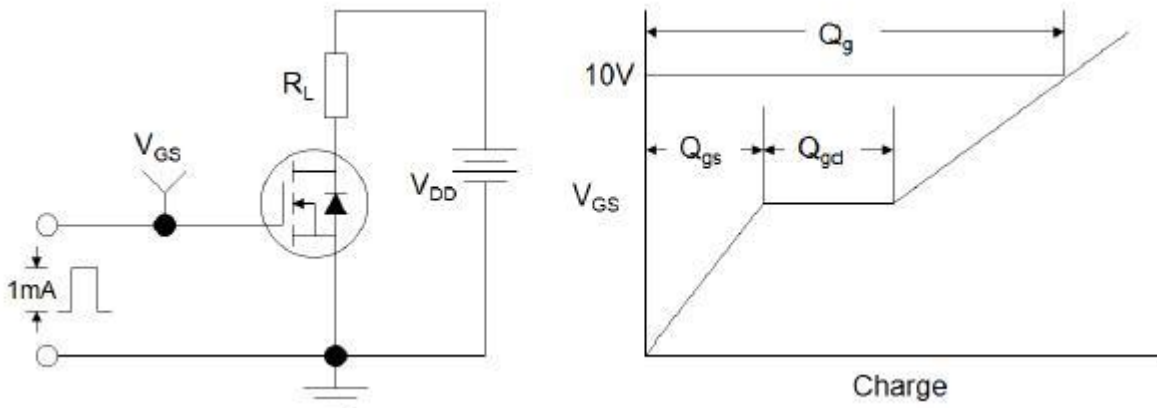


Figure1:Gate Charge Test Circuit & Waveform

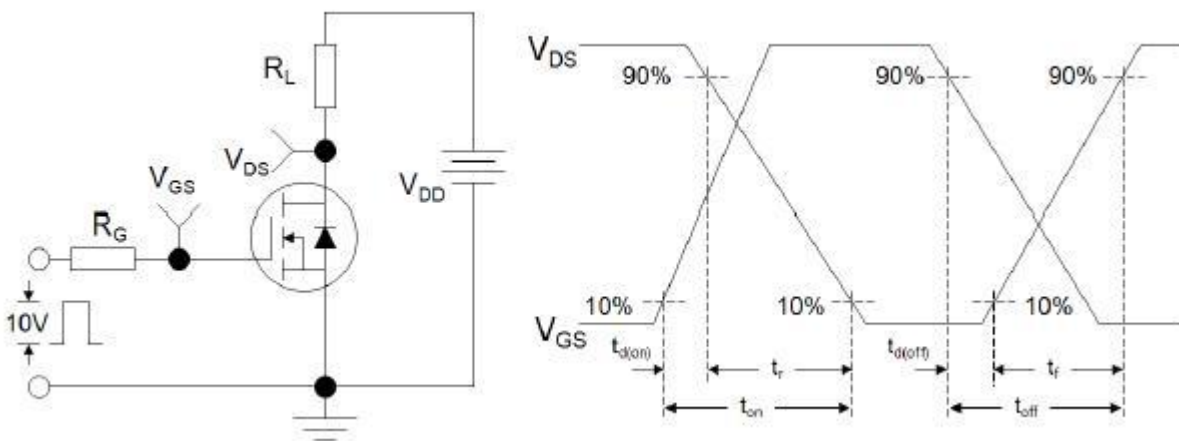


Figure 2: Resistive Switching Test Circuit & Waveforms

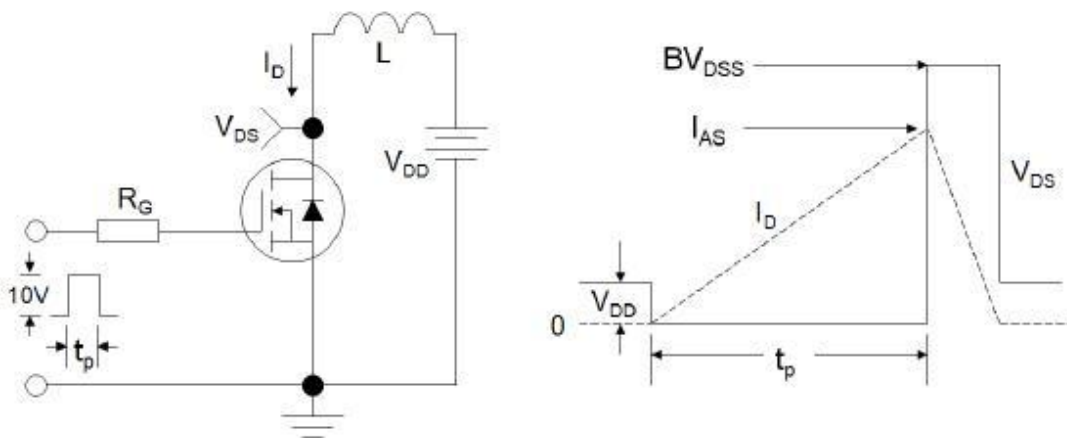
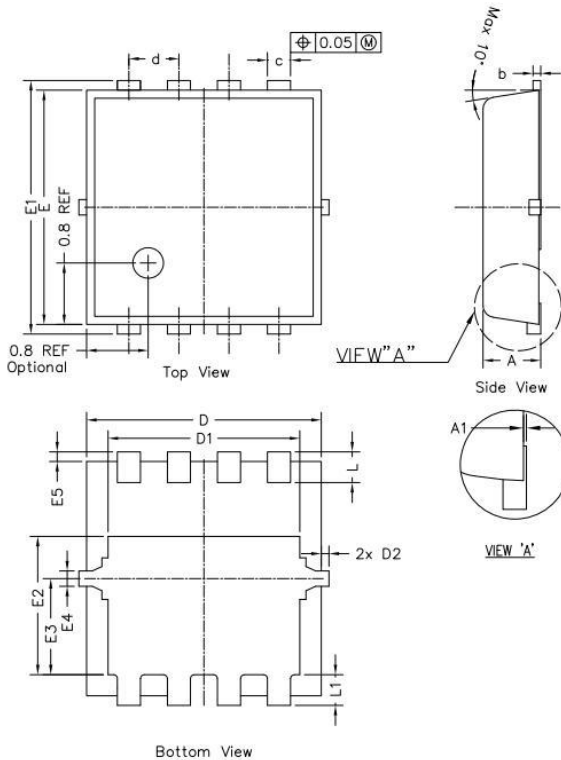


Figure 3:Unclamped Inductive Switching Test Circuit & Waveforms



## Package Mechanical Data-PDFN3x3-8L



SYMBOLS	DIMENSION IN MM			DIMENSION IN INCHES		
	MIN	NOM	MAX	MIN	NOM	MAX
A	0.700	0.750	0.800	0.028	0.030	0.031
A1	---	---	0.050	----	----	0.002
b	0.144	0.152	0.202	0.006	0.006	0.008
c	0.250	0.300	0.350	0.010	0.012	0.014
d	0.65 BSC			0.026 BSC		
D	2.950	3.050	3.150	0.116	0.120	0.124
D1	2.390	2.490	2.590	0.094	0.098	0.102
D2	---	---	0.125	---	---	0.005
E	2.950	3.050	3.150	0.116	0.120	0.124
E1	3.200	3.300	3.400	0.126	0.130	0.134
E2	1.700	1.800	1.900	0.067	0.071	0.075
E3	1.150	1.250	1.350	0.045	0.049	0.053
E4	0.150	0.200	0.250	0.006	0.008	0.010
E5	0.075	0.125	0.175	0.003	0.005	0.007
L	0.300	0.400	0.500	0.01	0.02	0.02
L1	0.300	0.400	0.500	0.01	0.02	0.02

Information furnished in this document is believed to be accurate and reliable. However, Jiangsu JieJie Microelectronics Co.,Ltd assumes no responsibility for the consequences of use without consideration for such information nor use beyond it.

Information mentioned in this document is subject to change without notice, apart from that when an agreement is signed, Jiangsu JieJie complies with the agreement.

Products and information provided in this document have no infringement of patents. Jiangsu JieJie assumes no responsibility for any infringement of other rights of third parties which may result from the use of such products and information.



is a registered trademark of Jiangsu JieJie Microelectronics Co.,Ltd.

Copyright ©2022 Jiangsu JieJie Microelectronics Co.,Ltd. Printed All rights reserved.