

### Product Summary

$V_{RRM}$	650 V
$I_F (T_C=155^\circ\text{C})$	15 A
$Q_C$	46 nC

### Features

- Extremely low reverse current
- No reverse recovery current
- Temperature independent switching
- Positive temperature coefficient on  $V_F$
- Excellent surge current capability
- Low capacitive charge

### Benefits

- Essentially no switching losses
- System efficiency improvement over Si diodes
- Increased power density
- Enabling higher switching frequency
- Reduction of heat sink requirements
- System cost savings due to smaller magnetics
- Reduced EMI

### Applications

- Switch mode power supplies (SMPS)
- Uninterruptible power supplies
- Motor drivers
- Power factor correction

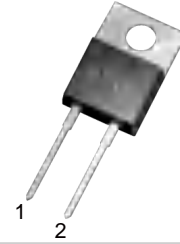
### Package Pin Definitions

- Pin1 and backside - Cathode
- Pin2 - Anode

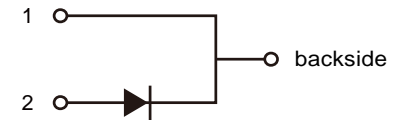
### Package Parameters

Part Number	Marking	Package
B2D15065K	B2D15065K	TO-220-2

### Package: TO-220-2



### Electrical Connection



**Maximum Ratings ( $T_c=25^\circ\text{C}$  unless otherwise specified)**

Symbol	Parameter	Test conditions	Value	Unit
$V_{RRM}$	Repetitive peak reverse voltage		650	V
$V_{RSM}$	Non-repetitive peak reverse voltage		650	V
$I_F$	Continuous forward current	$T_c=25^\circ\text{C}$ $T_c=155^\circ\text{C}$	57 15	A
$I_{FSM}$	Non-repetitive forward surge current	$T_c=25^\circ\text{C}$ , $t_p=10\text{ms}$ Half sine wave	120	A
$\int i^2 dt$	$i^2t$ value	$T_c=25^\circ\text{C}$ , $t_p=10\text{ms}$	72	A <sup>2</sup> S
$P_{tot}$	Power dissipation	$T_c=25^\circ\text{C}$ $T_c=110^\circ\text{C}$	211 91	W
$T_j$	Operating junction temperature		-55~175	°C
$T_{slg}$	Storage temperature		-55~175	°C
	TO-220 mounting torque	M3 Screw	0.7	Nm

**Thermal Characteristics**

Symbol	Parameter	Value			Unit
		Min.	Typ.	Max.	
$R_{th(jc)}$	Thermal resistance from junction to case		0.71		K/W

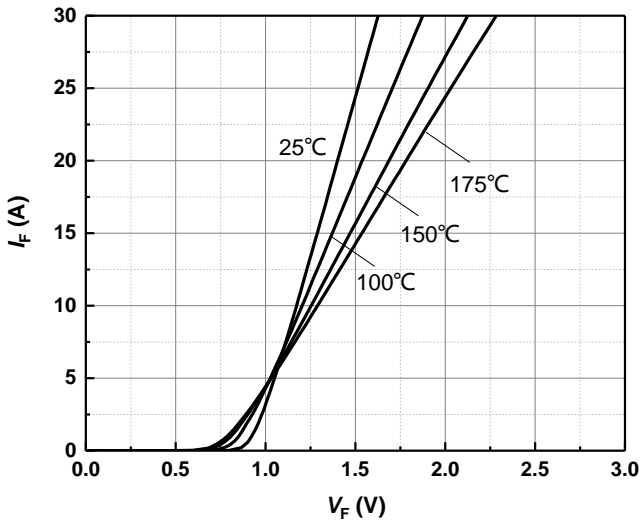
**Electrical Characteristics**  
**Static Characteristics**

Symbol	Parameter	Test conditions	Value			Unit
			Min.	Typ.	Max.	
$V_{DC}$	DC blocking voltage	$T_j=25^{\circ}C$	650			V
$V_F$	Diode forward voltage	$I_F=15A$ $T_j=25^{\circ}C$ $I_F=15A$ $T_j=175^{\circ}C$		1.29 1.54	1.52 2.0	V
$I_R$	Reverse current	$V_R=650V$ $T_j=25^{\circ}C$ $V_R=650V$ $T_j=175^{\circ}C$		1 15	100 150	$\mu A$

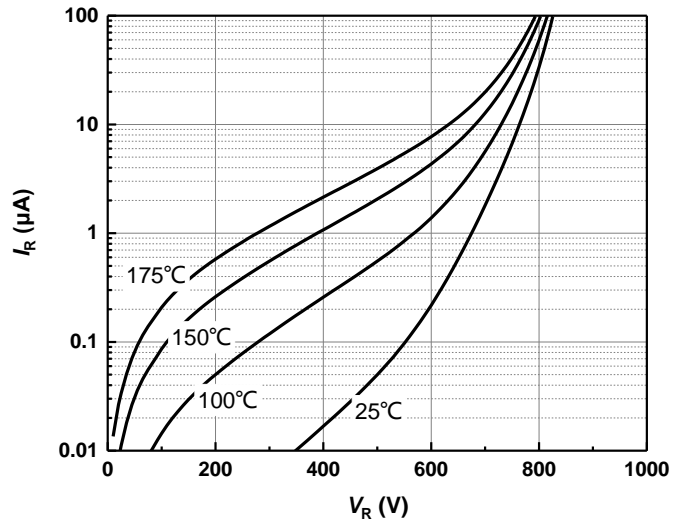
**AC Characteristics**

Symbol	Parameter	Test conditions	Value			Unit
			Min.	Typ.	Max.	
$Q_C$	Total capacitive charge	$V_R=400V$ $T_j=25^{\circ}C$ $Q_C=\int_0^{t_{VR}} C(V)dV$		46		nC
$C$	Total capacitance	$V_R=1V$ $f=1MHz$ $V_R=300V$ $f=1MHz$ $V_R=600V$ $f=1MHz$		713 79.7 79		pF
$E_C$	Capacitance stored energy	$V_R=400V$		12		$\mu J$

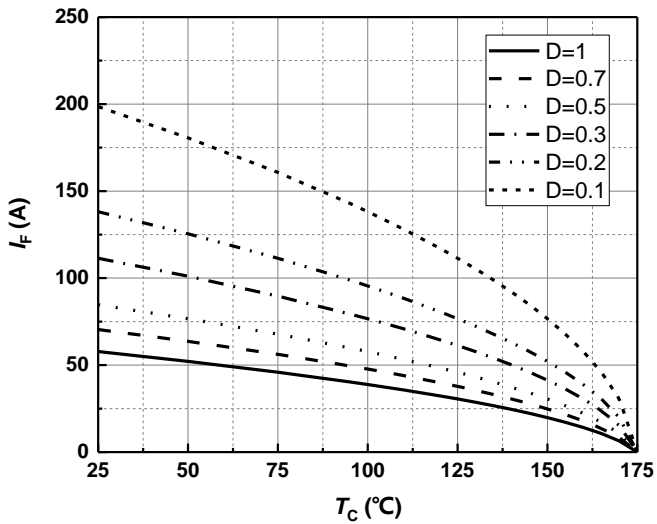
**Typical Performance**



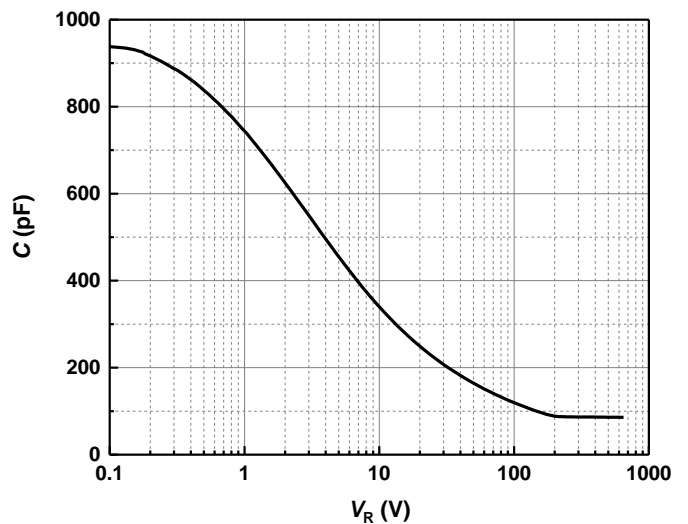
**Figure 1** Typical forward characteristics



**Figure 2** Typical reverse current as function of reverse voltage

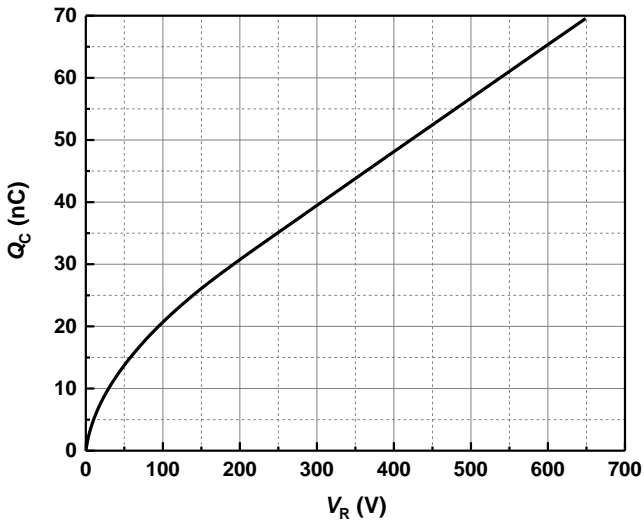


**Figure 3** Diode forward current as function of temperature, D=duty cycle

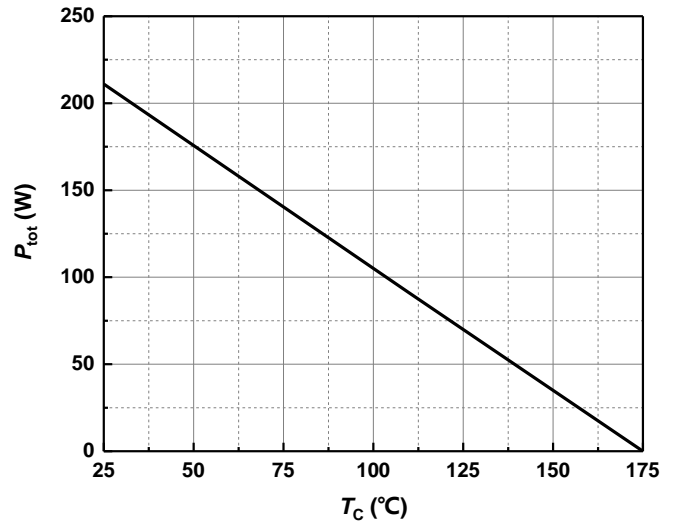


**Figure 4** Typical capacitance as function of reverse voltage,  $C=f(V_R)$ ;  $T_j=25^{\circ}$ C;  $f=1$  MHz

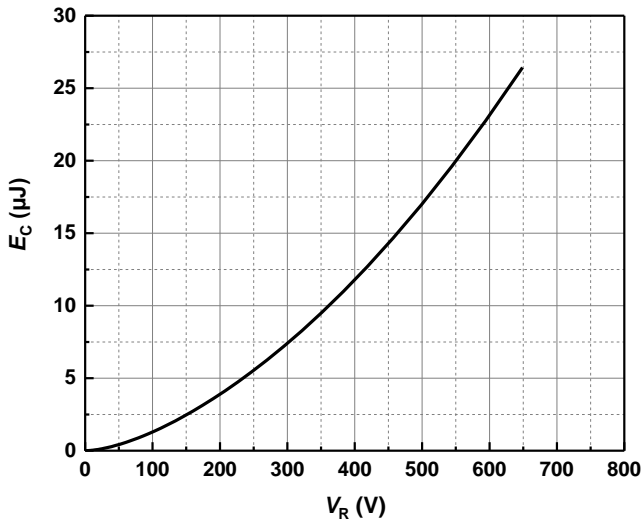
**Typical Performance**



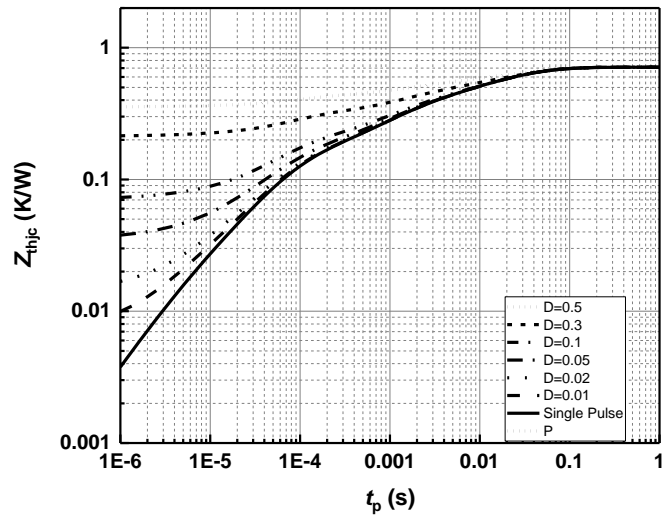
**Figure 5** Typical reverse charge as function of reverse voltage



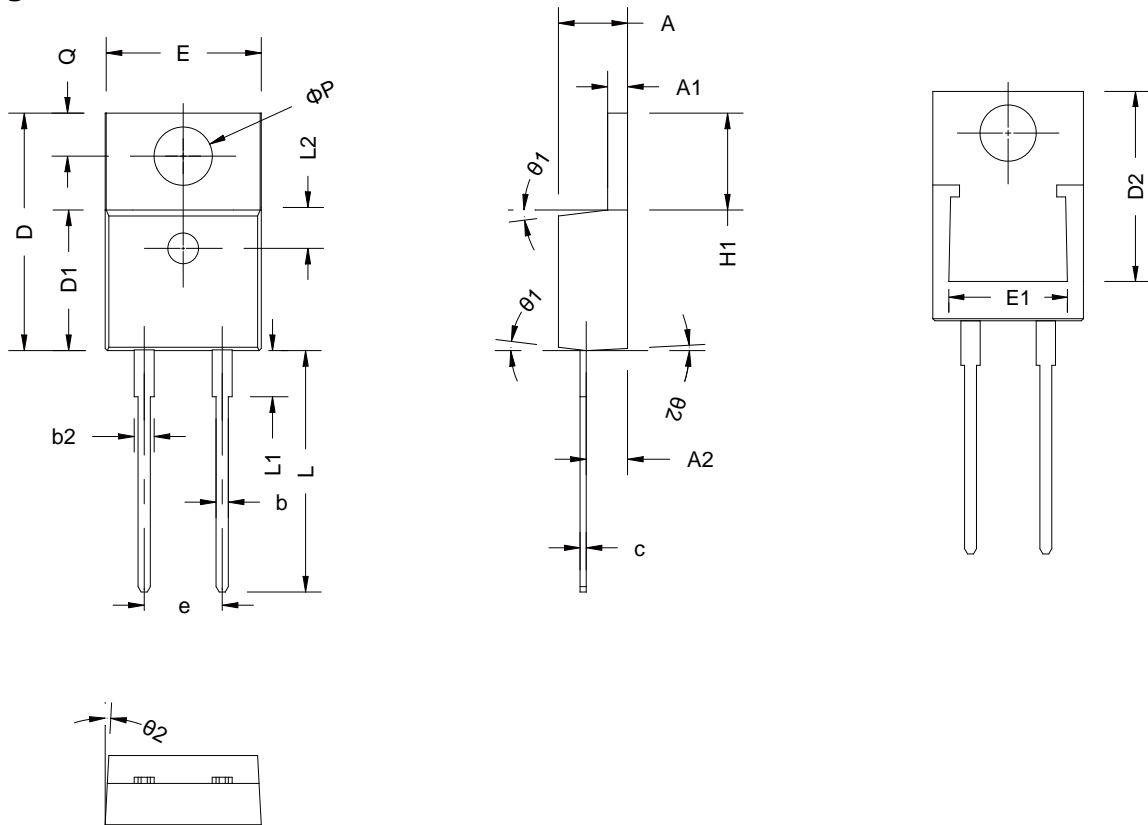
**Figure 6** Power dissipation as function of case temperature



**Figure 7** Capacitance stored energy



**Figure 8** Max. transient thermal impedance,  $Z_{thjc} = f(t)$ , parameter:  $D = t / T$

**Package Dimensions**


SYMBOL	mm		
	MIN	NOM	MAX
A	4.37	4.57	4.77
A1	1.22	-	1.40
A2	2.49	2.69	2.89
b	0.75	-	0.96
b2	1.22	-	1.47
c	0.30	-	0.48
D	15.15	15.45	15.75
D1	9.05	9.15	9.25
D2	11.40	-	12.88
E	9.86	10.16	10.36
E1	6.86	-	8.89
e	4.98	5.08	5.18
H1	6.10	6.30	6.50
L	12.70	-	13.70
L1	-	-	4.10
L2	2.50 REF		
φ P	3.70	3.84	3.99
Q	2.54	-	2.94
θ1	5°	7°	9°
θ2	1°	3°	5°

**Revision History**

<b>Document Version</b>	<b>Date of Release</b>	<b>Description of Changes</b>
Rev. 1.0	2021-01-26	Release of the datasheet.
Rev. 1.1	2021-12-06	Updated.
Rev. 1.2	2022-05-25	Updated.

**BASiC Semiconductor Ltd.**  
**Shenzhen, China**  
**© 2022 BASiC Semiconductor Ltd.**  
**All Rights Reserved.**

**Information**

For further information on technology, delivery terms and conditions and prices, please contact the nearest BASiC Semiconductor Office

**Disclaimer**

The information given in this document shall in no event be regarded as a guarantee of conditions or characteristics. With respect to any examples or hints given herein, any typical values stated herein and/or any information regarding the application of the device, BASiC semiconductor Ltd. hereby disclaims any and all warranties and liabilities of any kind, including without limitation, warranties of non-infringement of intellectual property rights of any third party.