

Product Summary

V_{RRM}	1200 V
$I_F (T_C=160^\circ\text{C})$	20 A
Q_C	120 nC

Features

- Low leakage current (I_R)
- Zero reverse recovery current
- Temperature independent switching behavior
- Positive temperature coefficient on V_F
- High surge current capacity
- Low capacitive charge

Benefits

- System cost savings due to smaller magnetics
- System efficiency improvement over Si diodes
- Reduction of heat sink requirements
- Enabling higher frequency
- Reduced EMI

Applications

- Switch mode power supplies (SMPS)
- Uninterruptible power supplies
- Server/telecom power supplies
- Power factor correction
- Solar

Package Pin Definitions

- Pin1 and backside - Cathode
- Pin2 - Anode

Package Parameters

Part Number	Marking	Package
B2D20120H1	B2D20120H1	TO-247-2

Package: TO-247-2



Electrical Connection

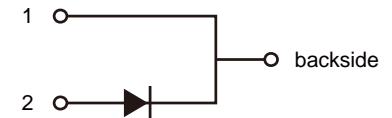

Maximum Ratings ($T_c=25^\circ\text{C}$ unless otherwise specified)

Symbol	Parameter	Test conditions	Value	Unit
V_{RRM}	Repetitive peak reverse voltage		1200	V
V_{RSM}	Non-repetitive peak reverse voltage		1200	V
E_{AS}	Single pulse avalanche energy	$T_c=25^\circ\text{C}$, $L=1\text{mH}$, $I_{AS}=15\text{A}$, $V=140\text{V}$	113	mJ
I_F	Continuous forward current	$T_c=25^\circ\text{C}$	77	A
		$T_c=135^\circ\text{C}$	36	
		$T_c=160^\circ\text{C}$	20	
I_{FSM}	Non-repetitive forward surge current	$T_c=25^\circ\text{C}$, $t_p=10\text{ms}$ Half sine wave	190	A
$\int i^2 dt$	i^2t value	$T_c=25^\circ\text{C}$, $t_p=10\text{ms}$	180.5	A^2S
P_{tot}	Power dissipation	$T_c=25^\circ\text{C}$	366	W
		$T_c=110^\circ\text{C}$	159	
T_j	Operating junction temperature		-55~175	$^\circ\text{C}$
T_{stg}	Storage temperature		-55~175	$^\circ\text{C}$
	TO-247 mounting torque	M3 Screw	0.7	Nm

Thermal Characteristics

Symbol	Parameter	Value			Unit
		Min.	Typ.	Max.	
$R_{th(jc)}$	Thermal resistance from junction to case		0.41		K/W

Electrical Characteristics
Static Characteristics

Symbol	Parameter	Test conditions	Value			Unit
			Min.	Typ.	Max.	
V_{DC}	DC blocking voltage	$T_j=25^{\circ}C$	1200			V
V_F	Diode forward voltage	$I_F=20A T_j=25^{\circ}C$ $I_F=20A T_j=175^{\circ}C$		1.35 1.78	1.6 2.7	V
I_R	Reverse current	$V_R=1200V T_j=25^{\circ}C$ $V_R=1200V T_j=175^{\circ}C$		20 40	160 400	μA

AC Characteristics

Symbol	Parameter	Test conditions	Value			Unit
			Min.	Typ.	Max.	
Q_C	Total capacitive charge	$V_R=800V T_j=25^{\circ}C$ $Q_C=\int_0^{V_R} C(V)dV$		120		nC
C	Total capacitance	$V_R=1V f=1MHz$ $V_R=400V f=1MHz$ $V_R=800V f=1MHz$		1342 112 85		pF
E_C	Capacitance stored energy	$V_R=800V$		62		μJ

Typical Performance

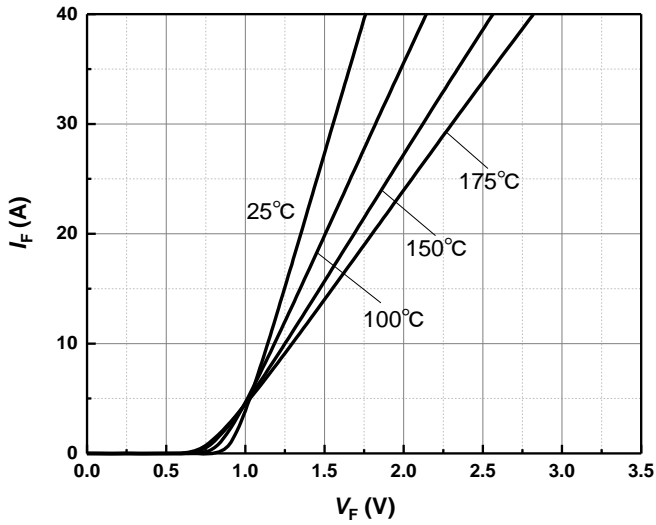

Figure 1 Typical forward characteristics

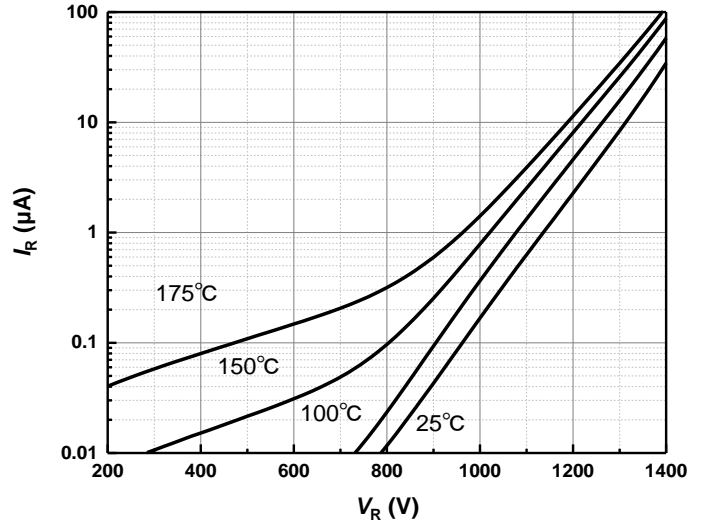

Figure 2 Typical reverse current as function of reverse voltage

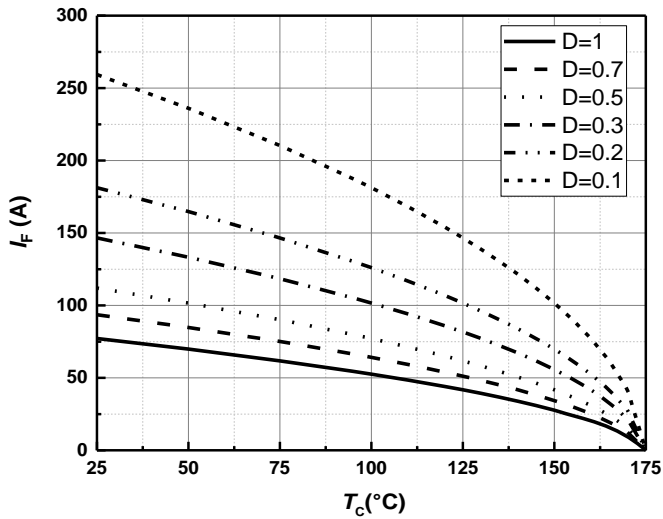

Figure 3 Diode forward current as function of temperature, D=duty cycle

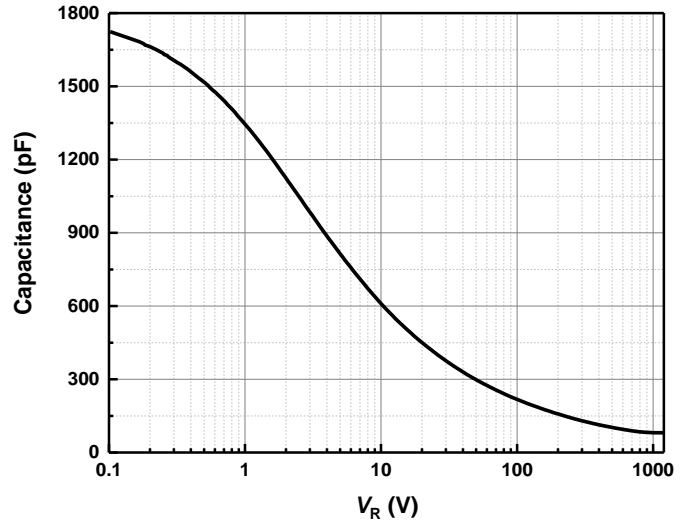

Figure 4 Typical capacitance as function of reverse voltage, $C=f(V_R)$; $T_j=25^{\circ}$ C; $f=1$ MHz

Typical Performance

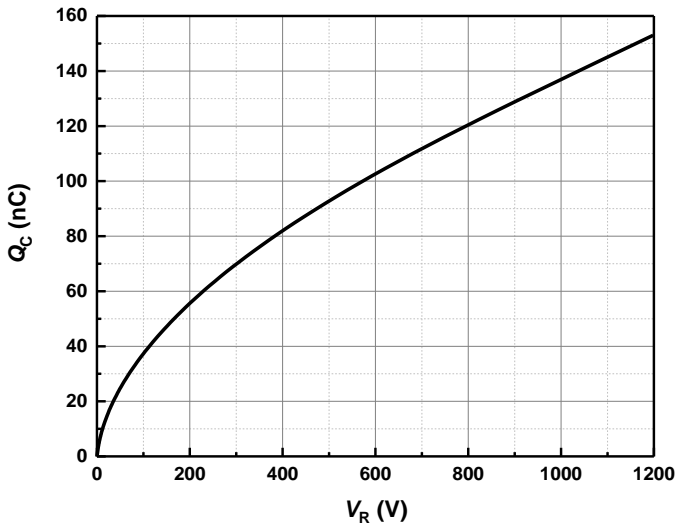

Figure 5 Typical reverse charge as function of reverse voltage

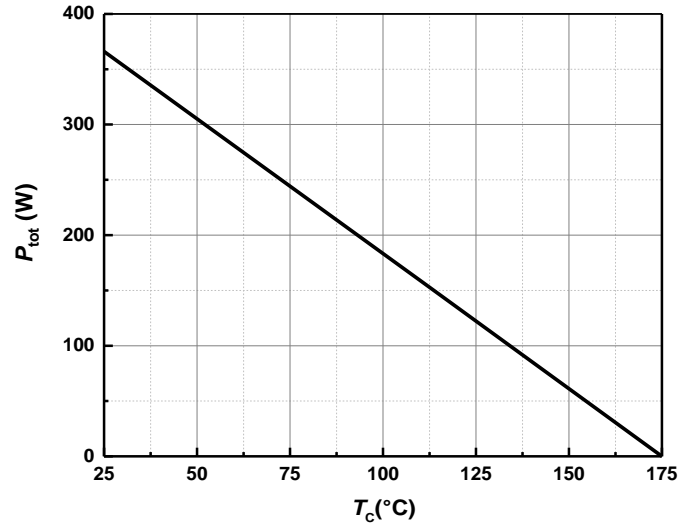

Figure 6 Power dissipation as function of case temperature

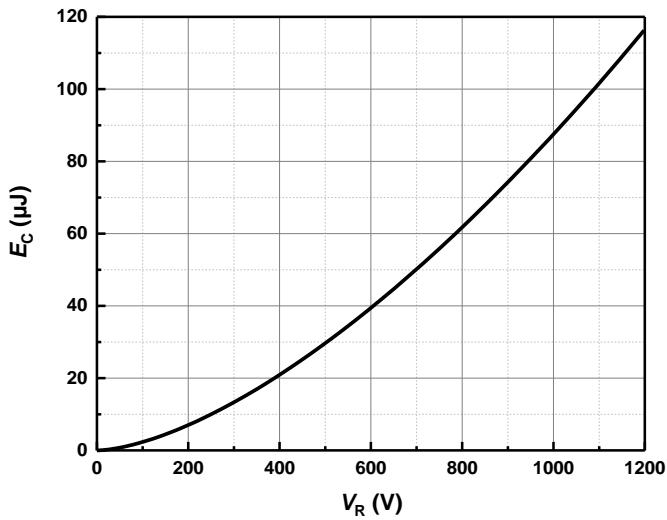

Figure 7 Capacitance stored energy

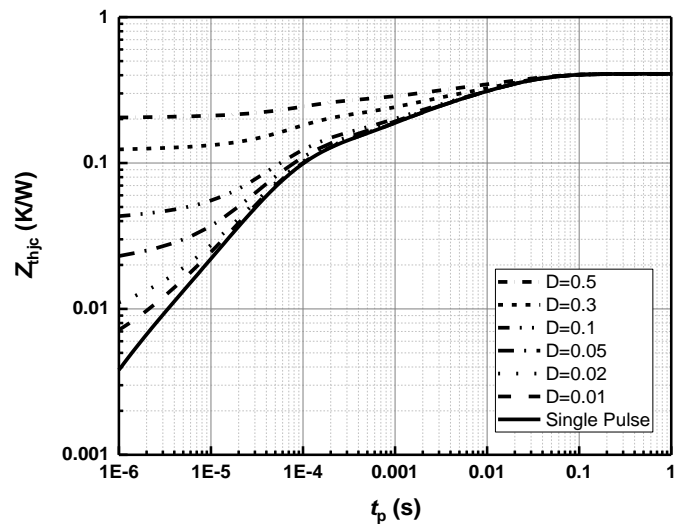
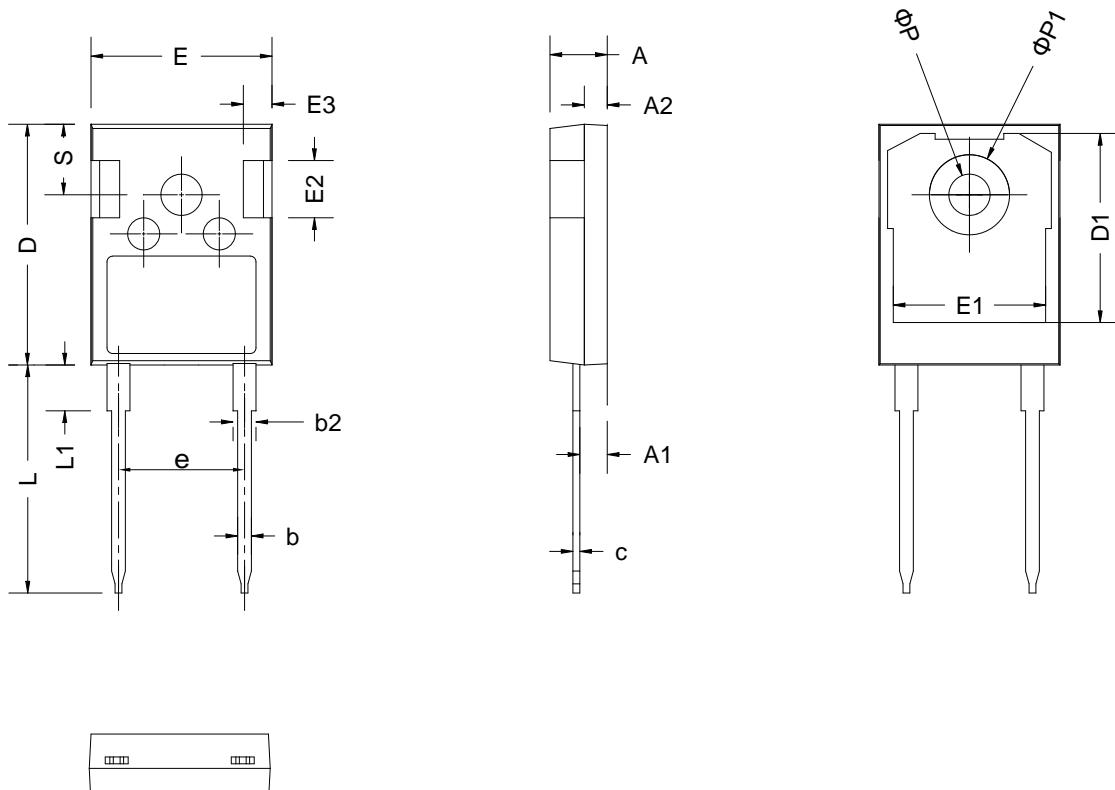
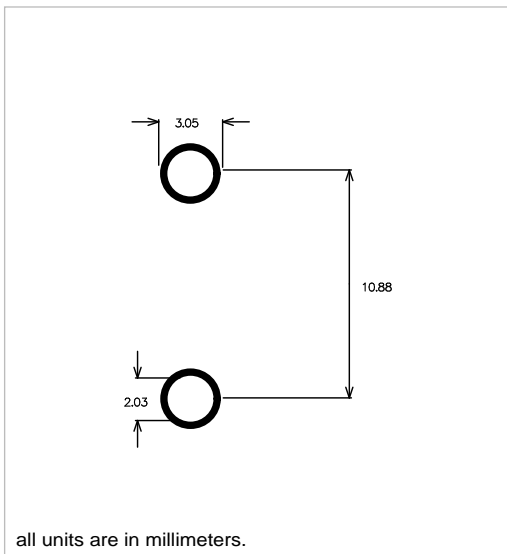

Figure 8 Max. transient thermal impedance, $Z_{thjc} = f(t)$, parameter: $D = t / T$

Package Dimensions



Recommended Solder Pad Layout



SYMBOL	mm		
	MIN	NOM	MAX
A	4.80	5.00	5.20
A1	2.21	2.41	2.61
A2	1.85	2.00	2.15
b	1.11	1.21	1.36
b2	1.91	2.01	2.21
c	0.51	0.61	0.75
D	20.70	21.00	21.30
D1	16.25	16.55	16.85
E	15.50	15.80	16.10
E1	13.00	13.30	13.60
E2	4.80	5.00	5.20
E3	2.30	2.50	2.70
e	10.88 BSC		
L	19.62	19.92	20.22
L1	-	-	4.30
φ P	3.40	3.60	3.80
φ P1	-	-	7.30
S	6.15 BSC		

Revision History

Document Version	Date of Release	Description of Changes
Rev. 0.0	2022-05-27	Release of the datasheet.
Rev. 0.1	2023-03-03	Characteristics update.

BASiC Semiconductor Ltd.
Shenzhen, China
© 2023 BASiC Semiconductor Ltd.
All Rights Reserved.

Information

For further information on technology, delivery terms and conditions and prices, please contact the nearest BASiC Semiconductor Office

Disclaimer

The information given in this document shall in no event be regarded as a guarantee of conditions or characteristics. With respect to any examples or hints given herein, any typical values stated herein and/or any information regarding the application of the device, BASiC semiconductor Ltd. hereby disclaims any and all warranties and liabilities of any kind, including without limitation, warranties of non-infringement of intellectual property rights of any third party.