

Product Summary

V_{RRM}	1200 V
$I_F (T_C=150^\circ\text{C})$	40 A**
Q_C	240 nC**

Features

- Extremely low reverse current
- No reverse recovery current
- Temperature independent switching
- Positive temperature coefficient on V_F
- Excellent surge current capability
- Low capacitive charge

Benefits

- Essentially no switching losses
- System efficiency improvement over Si diodes
- Increased power density
- Enabling higher switching frequency
- Reduction of heat sink requirements
- System cost savings due to smaller magnetics
- Reduced EMI

Applications

- Switch mode power supplies (SMPS)
- Uninterruptible power supplies
- Motor drivers
- Power factor correction

Package Pin Definitions

- Pin1 - Anode
- Pin2 and backside - Cathode
- Pin3 - Anode

Package Parameters

Part Number	Marking	Package
B2D40120HC1	B2D40120HC1	TO-247-3

* Per Leg, ** Per Device

Package: TO-247-3

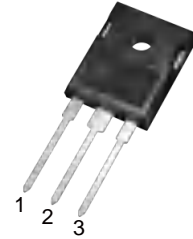

Electrical Connection

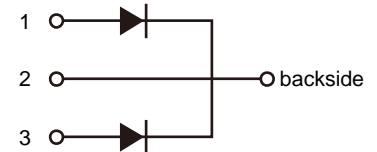

Maximum Ratings ($T_c=25^\circ\text{C}$ unless otherwise specified)

Symbol	Parameter	Test conditions	Value	Unit
V_{RRM}	Repetitive peak reverse voltage		1200	V
V_{RSM}	Non-repetitive peak reverse voltage		1200	V
I_F	Continuous forward current	$T_c=25^\circ\text{C}$ $T_c=150^\circ\text{C}$	60*/120** 20*/40**	A
I_{FSM}	Non-repetitive forward surge current	$T_c=25^\circ\text{C}$, $t_p=10\text{ms}$ Half sine wave	180*	A
$\int i^2 dt$	i^2t value	$T_c=25^\circ\text{C}$, $t_p=10\text{ms}$	162*	A ² S
P_{tot}	Power dissipation	$T_c=25^\circ\text{C}$ $T_c=110^\circ\text{C}$	259* 112*	W
T_j	Operating junction temperature		-55~175	$^\circ\text{C}$
T_{slg}	Storage temperature		-55~175	$^\circ\text{C}$
	TO-247 mounting torque	M3 Screw	0.7	Nm

* Per Leg, ** Per Device

Thermal Characteristics

Symbol	Parameter	Value			Unit
		Min.	Typ.	Max.	
$R_{th(jc)}$	Thermal resistance from junction to case		0.58*/ 0.28**		K/W

* Per Leg, ** Per Device

Electrical Characteristics (Per Leg)
Static Characteristics

Symbol	Parameter	Test conditions	Value			Unit
			Min.	Typ.	Max.	
V_{DC}	DC blocking voltage	$T_J=25^{\circ}C$	1200			V
V_F	Diode forward voltage	$I_F=20A$ $T_J=25^{\circ}C$ $I_F=20A$ $T_J=175^{\circ}C$		1.36 1.92	1.6 2.9	V
I_R	Reverse current	$V_R=1200V$ $T_J=25^{\circ}C$ $V_R=1200V$ $T_J=175^{\circ}C$		5 30	160 300	μA

AC Characteristics

Symbol	Parameter	Test conditions	Value			Unit
			Min.	Typ.	Max.	
Q_C	Total capacitive charge	$V_R=800V$ $T_J=25^{\circ}C$ $Q_C=\int_0^{V_R} C(V)dV$		120		nC
C	Total capacitance	$V_R=1V$ $f=1MHz$ $V_R=400V$ $f=1MHz$ $V_R=800V$ $f=1MHz$		1408 112 82		pF
E_C	Capacitance stored energy	$V_R=800V$		62		μJ

Typical Performance (Per Leg)

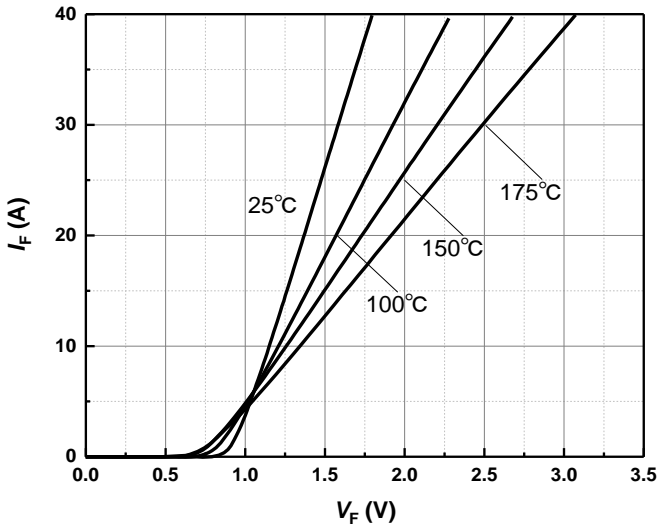

Figure 1 Typical forward characteristics

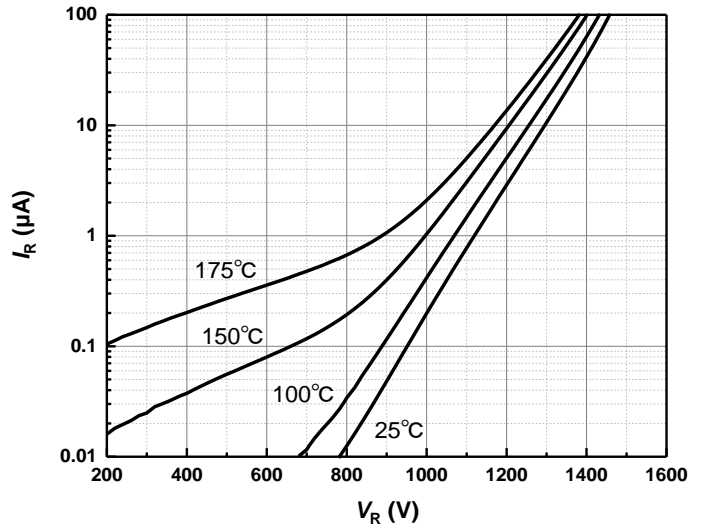

Figure 2 Typical reverse current as function of reverse voltage

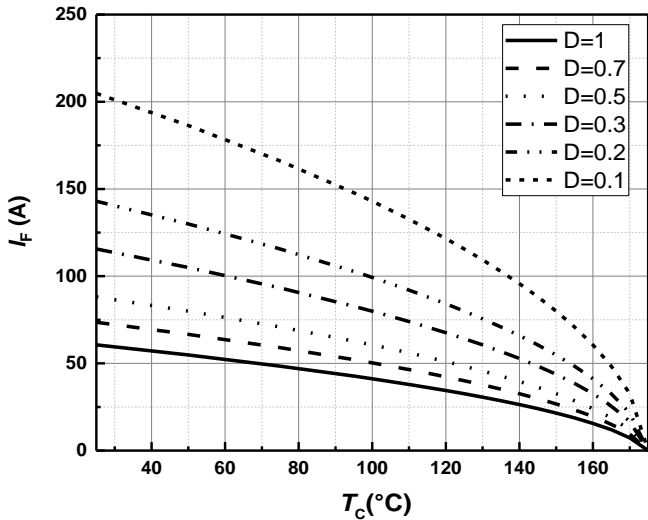

Figure 3 Diode forward current as function of temperature, D=duty cycle

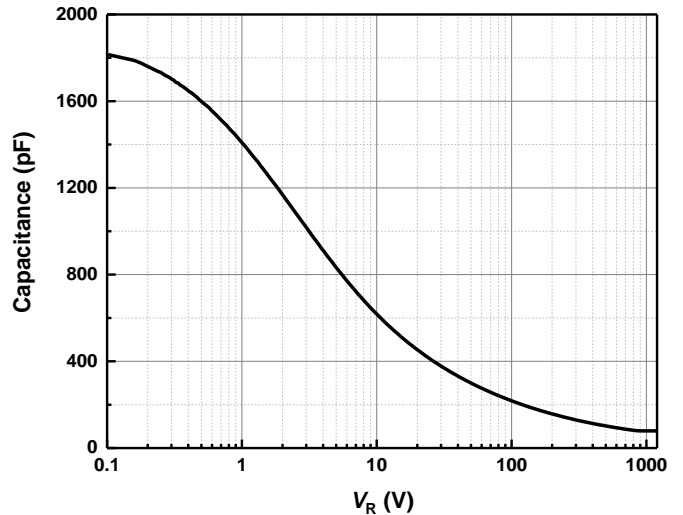

Figure 4 Typical capacitance as function of reverse voltage, $C=f(V_R)$; $T_j=25^{\circ}$ C; $f=1$ MHz

Typical Performance

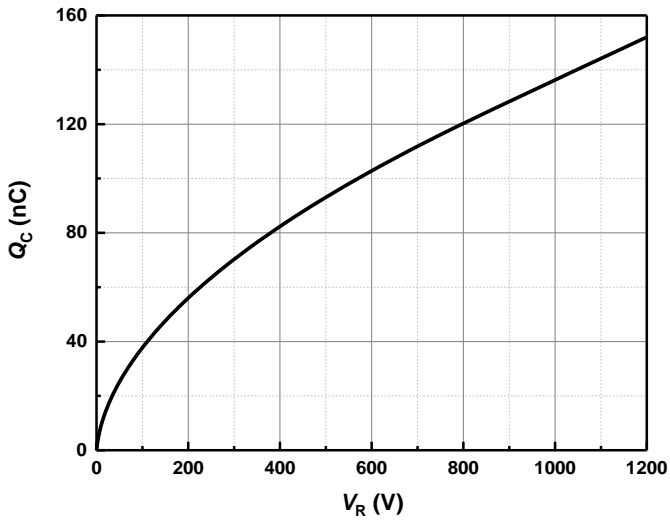

Figure 5 Typical reverse charge as function of reverse voltage

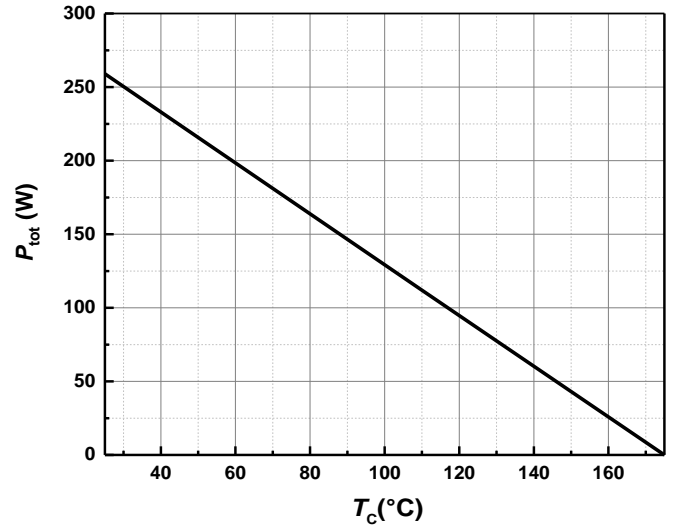

Figure 6 Power dissipation as function of case temperature

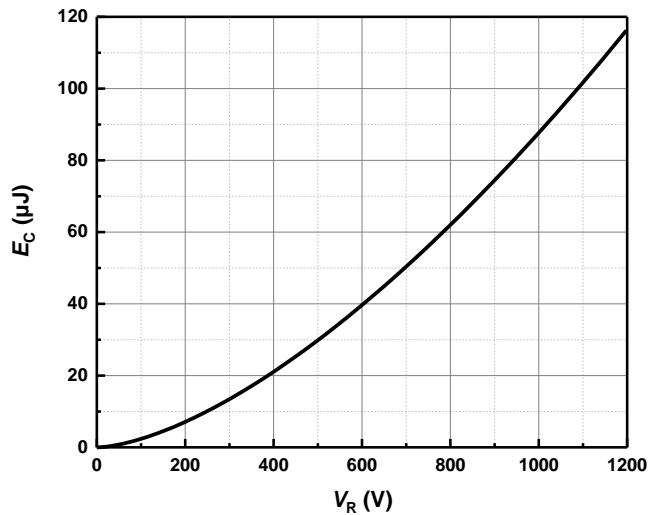

Figure 7 Capacitance stored energy

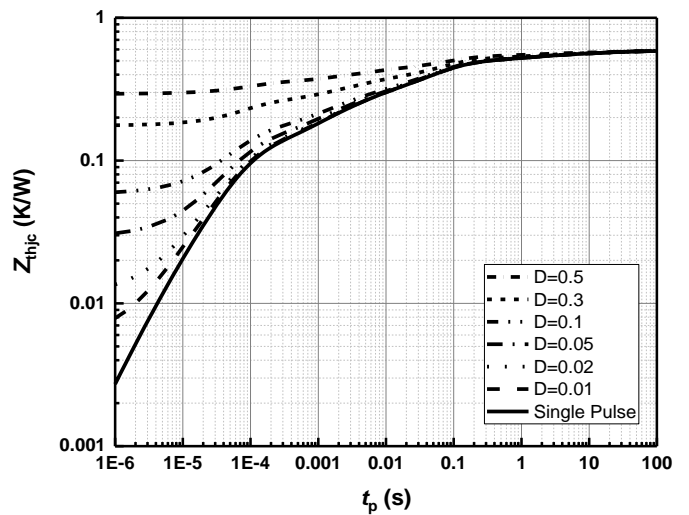
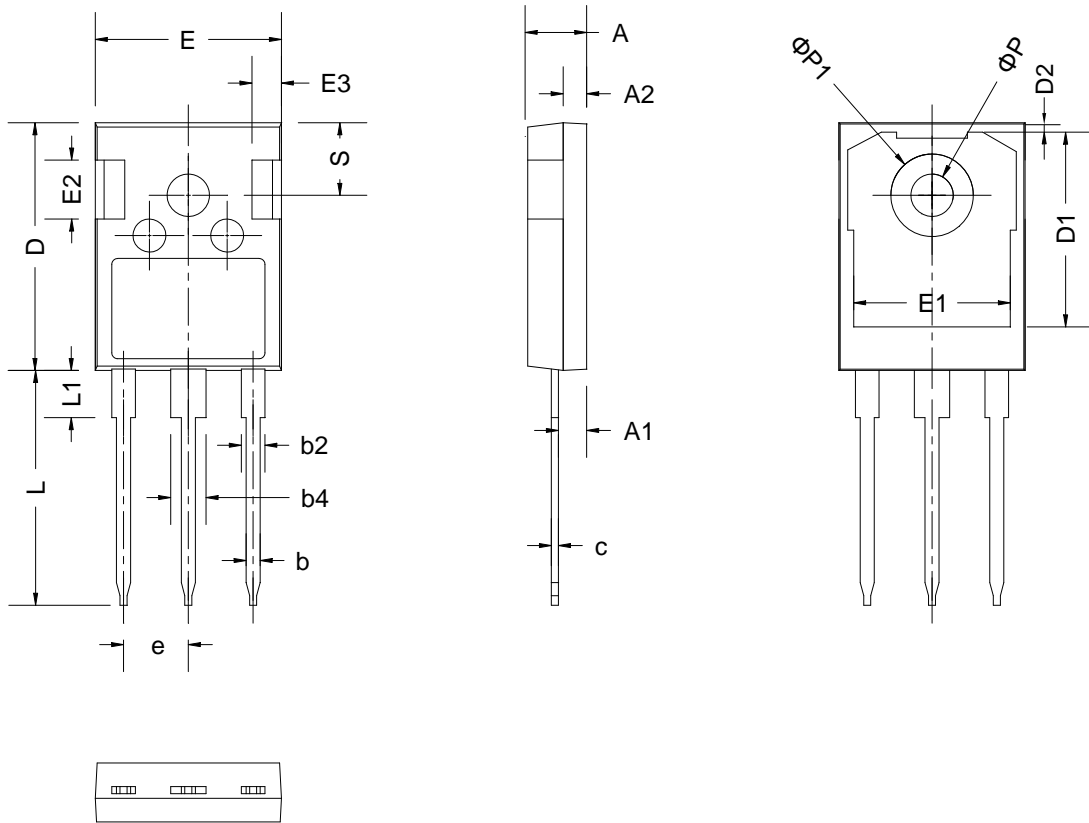

Figure 8 Max. transient thermal impedance, $Z_{thjc} = f(t)$, parameter: $D = t / T$

Package Dimensions

SYMBOL	mm		
	MIN	NOM	MAX
A	4.80	5.00	5.20
A1	2.21	2.41	2.59
A2	1.85	2.00	2.15
b	1.11	-	1.36
b2	1.91	2.01	2.21
b4	2.91	-	3.41
c	0.51	-	0.75
D	20.80	21.00	21.30
D1	16.25	16.55	16.85
D2	1.05	1.17	1.35
E	15.50	15.80	16.10
E1	13.00	13.30	13.60
E2	4.40	-	5.20
E3	1.50	-	2.70
e	5.436BSC		
L	19.62	19.92	20.22
L1	-	-	4.30
φ P	3.40	3.60	3.80
φ P1	-	-	7.40
S	6.00	6.15	6.30

Revision History

Document Version	Date of Release	Description of Changes
Rev 0.0	2022-06-15	Release of the datasheet.

BASiC Semiconductor Ltd.
Shenzhen, China
© 2022 BASiC Semiconductor Ltd.
All Rights Reserved.

Information

For further information on technology, delivery terms and conditions and prices, please contact the nearest BASiC Semiconductor Office

Disclaimer

The information given in this document shall in no event be regarded as a guarantee of conditions or characteristics. With respect to any examples or hints given herein, any typical values stated herein and/or any information regarding the application of the device, BASiC semiconductor Ltd. hereby disclaims any and all warranties and liabilities of any kind, including without limitation, warranties of non-infringement of intellectual property rights of any third party.