

### Product Summary

$V_{RRM}$	650 V
$I_F (T_C=160^\circ\text{C})$	6 A
$Q_c$	17 nC

### Features

- Low leakage current ( $I_R$ )
- Zero reverse recovery current
- Temperature independent switching behavior
- Positive temperature coefficient on  $V_F$
- High surge current capacity
- Low capacitive charge

### Benefits

- System cost savings due to smaller magnetics
- System efficiency improvement over Si diodes
- Reduction of heat sink requirements
- Enabling higher frequency
- Reduced EMI

### Applications

- Switch mode power supplies (SMPS)
- Uninterruptible power supplies
- Server/telecom power supplies
- Power factor correction
- Solar

### Package Pin Definitions

- Pin1 - NC
- Pin2 - Anode
- Pin3 and backside - Cathode

### Package Parameters

Part Number	Marking	Package
B2D06065E1	B2D06065E1	TO-252-3

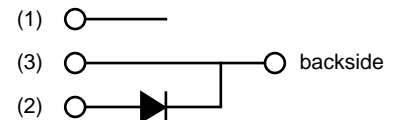
### Packing Quantities

Tape & Reel Packing	PCS/Reel	Reels/Box	PCS/Box
TO-252-3	2500	2	5000

### Package: TO-252-3



### Electrical Connection



**Maximum Ratings ( $T_c=25^\circ\text{C}$  unless otherwise specified)**

Symbol	Parameter	Test conditions	Value	Unit
$V_{RRM}$	Repetitive peak reverse voltage		650	V
$V_{RSM}$	Non-repetitive peak reverse voltage		650	V
$I_F$	Continuous forward current	$T_c=25^\circ\text{C}$	24	A
		$T_c=135^\circ\text{C}$	11	
		$T_c=160^\circ\text{C}$	6	
$I_{FSM}$	Non-repetitive forward surge current	$T_c=25^\circ\text{C}$ , $t_p=10\text{ms}$ Half sine wave	50	A
$\int i^2 dt$	$i^2t$ value	$T_c=25^\circ\text{C}$ , $t_p=10\text{ms}$	12.5	$\text{A}^2\text{S}$
$P_{tot}$	Power dissipation	$T_c=25^\circ\text{C}$	115	W
		$T_c=110^\circ\text{C}$	50	
$T_j$	Operating junction temperature		-55~175	$^\circ\text{C}$
$T_{slg}$	Storage temperature		-55~175	$^\circ\text{C}$

**Thermal Characteristics**

Symbol	Parameter	Value			Unit
		Min.	Typ.	Max.	
$R_{th(jc)}$	Thermal resistance from junction to case		1.30		K/W

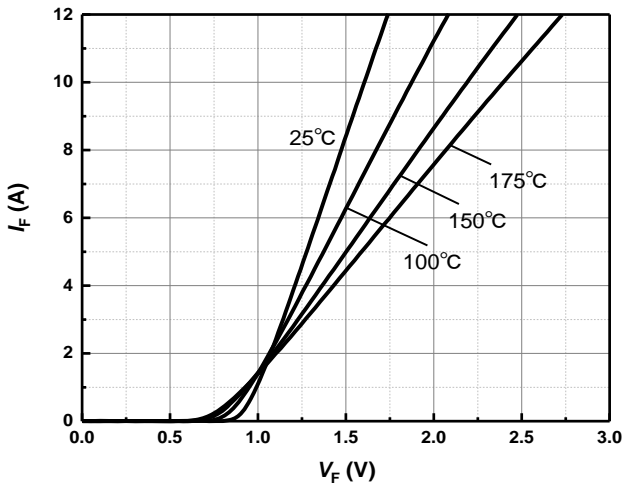
**Electrical Characteristics**  
**Static Characteristics**

Symbol	Parameter	Test conditions	Value			Unit
			Min.	Typ.	Max.	
$V_{DC}$	DC blocking voltage	$T_j=25^{\circ}C$	650			V
$V_F$	Diode forward voltage	$I_F=6A$ $T_j=25^{\circ}C$ $I_F=6A$ $T_j=175^{\circ}C$		1.32 1.7	1.6 2.5	V
$I_R$	Reverse current	$V_R=650V$ $T_j=25^{\circ}C$ $V_R=650V$ $T_j=175^{\circ}C$		5 20	70 200	$\mu A$

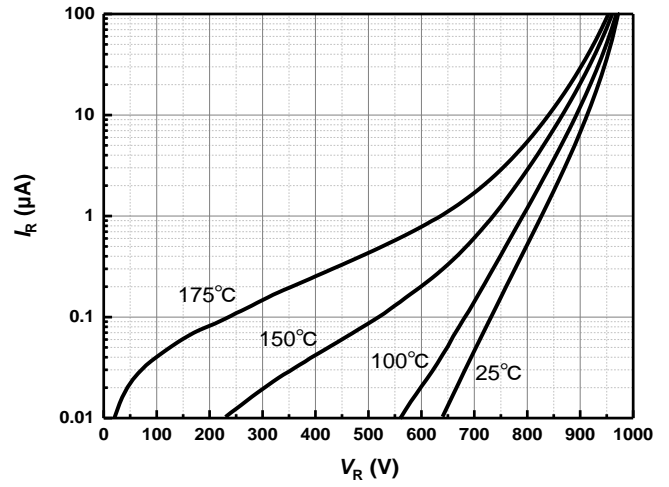
**AC Characteristics**

Symbol	Parameter	Test conditions	Value			Unit
			Min.	Typ.	Max.	
$Q_C$	Total capacitive charge	$V_R=400V$ $T_j=25^{\circ}C$ $Q_C=\int_0^{V_R} C(V)dV$		17		nC
$C$	Total capacitance	$V_R=1V$ $f=1MHz$ $V_R=300V$ $f=1MHz$ $V_R=600V$ $f=1MHz$		271 30 29		pF
$E_C$	Capacitance stored energy	$V_R=400V$		4.4		$\mu J$

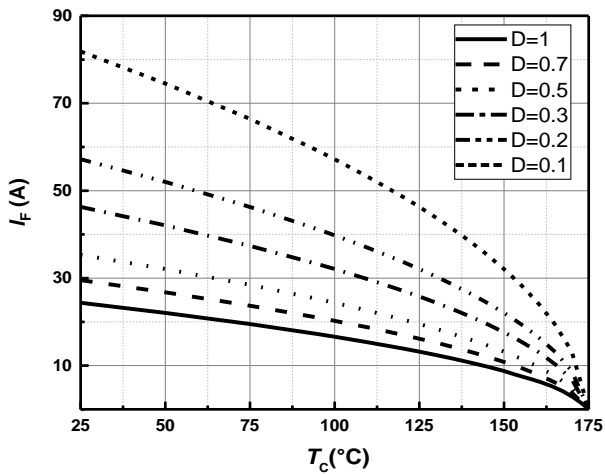
**Typical Performance**



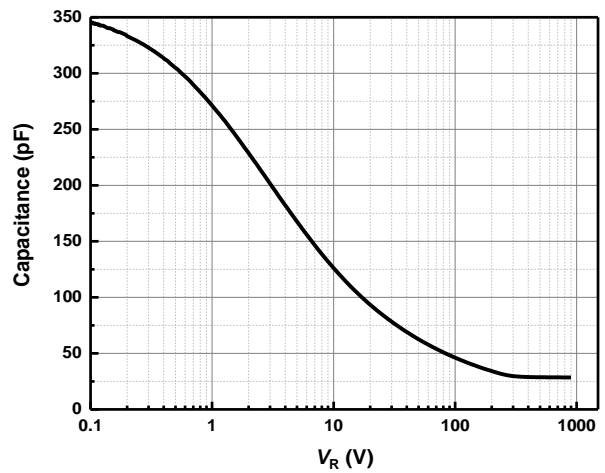
**Figure 1** Typical forward characteristics



**Figure 2** Typical reverse current as function of reverse voltage

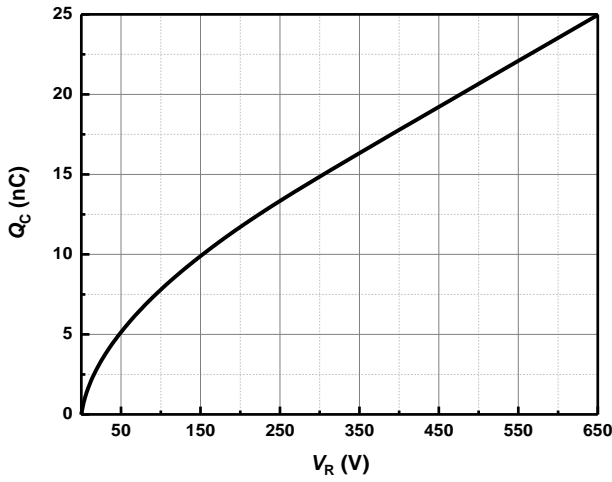


**Figure 3** Diode forward current as function of temperature, D=duty cycle

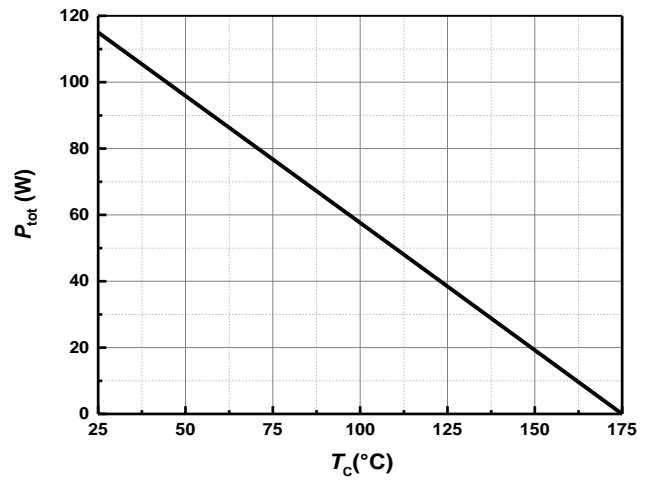


**Figure 4** Typical capacitance as function of reverse voltage,  $C=f(V_R)$ ;  $T_j=25^{\circ}$ C;  $f=1$  MHz

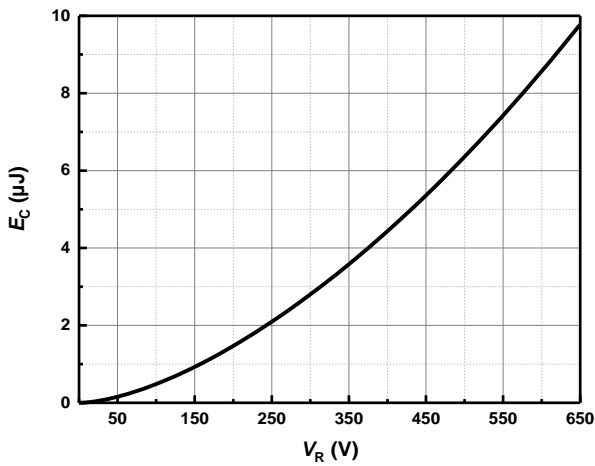
**Typical Performance**



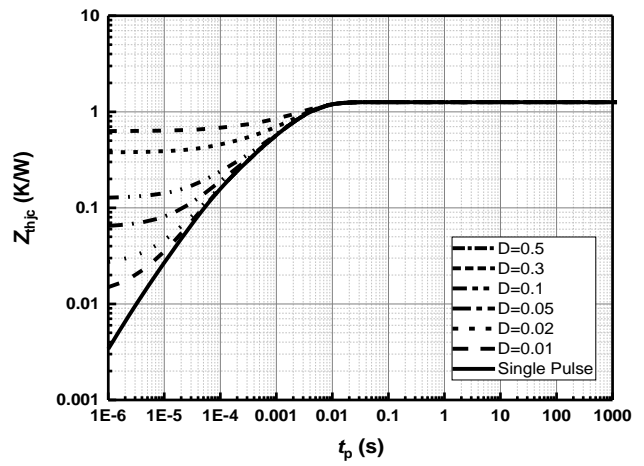
**Figure 5** Typical reverse charge as function of reverse voltage



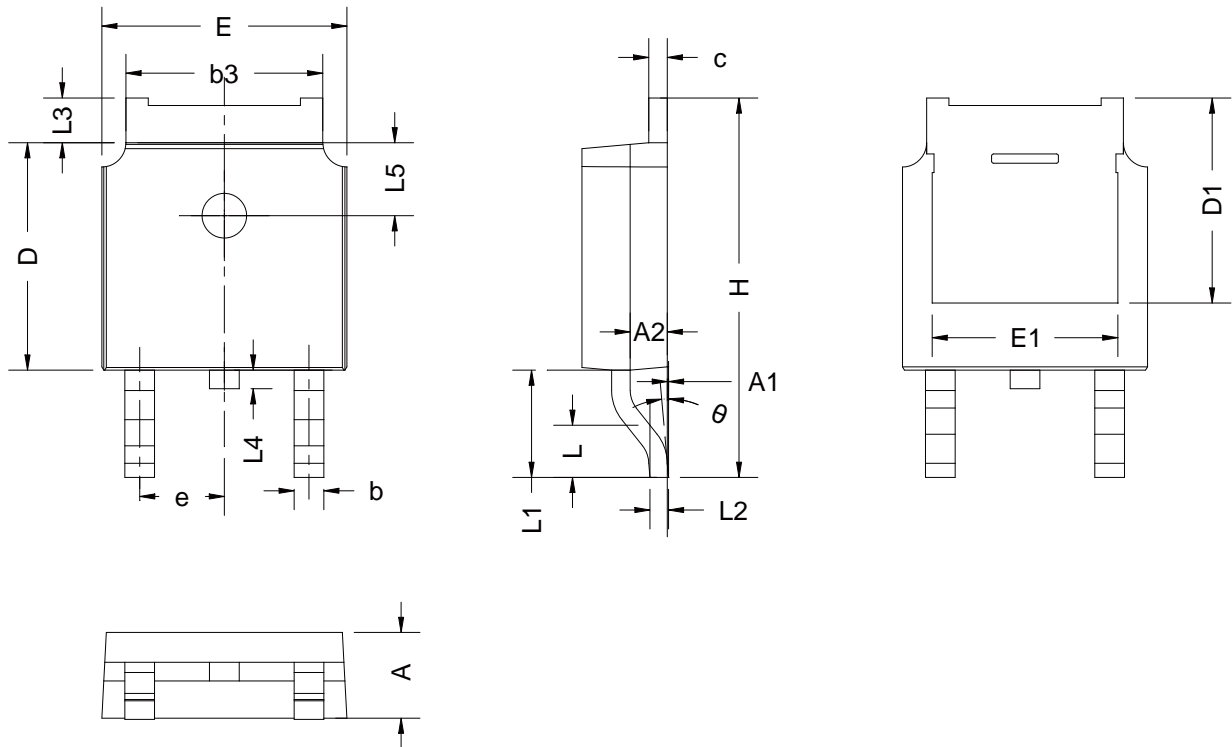
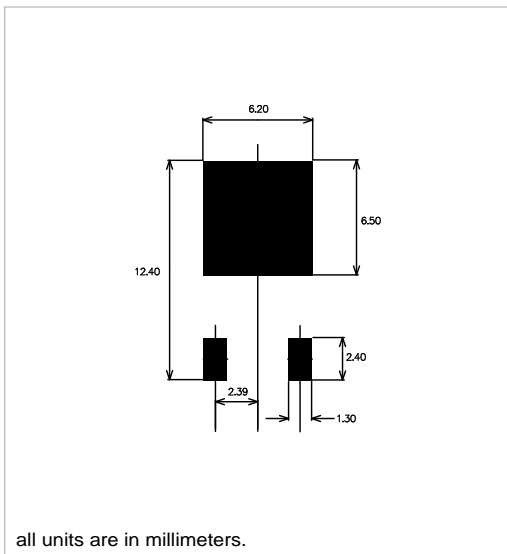
**Figure 6** Power dissipation as function of case temperature



**Figure 7** Capacitance stored energy



**Figure 8** Max. transient thermal impedance,  $Z_{thjc} = f(t)$ , parameter:  $D = t / T$

**Package Dimensions**

**Recommended Solder Pad Layout**


SYMBOL	mm		
	MIN	NOM	MAX
A	2.20	2.30	2.38
A1	0.00	-	0.20
A2	0.90	1.07	1.17
b	0.68	0.78	0.90
b3	5.23	5.33	5.46
c	0.43	0.53	0.61
D	5.98	6.10	6.22
D1	5.30 REF		
E	6.40	6.60	6.73
E1	4.63	-	-
e	2.286 BSC		
H	9.40	10.10	10.50
L	1.38	1.50	1.75
L1	2.90 REF		
L2	0.51 BSC		
L3	0.88	-	1.28
L4	0.50	-	1.00
L5	1.65	1.80	1.95
$\theta$	0°	-	8°

**Revision History**

<b>Document Version</b>	<b>Date of Release</b>	<b>Description of Changes</b>
Rev. 0.0	2023-03-09	Release of the datasheet.

**BASiC Semiconductor Ltd.**  
**Shenzhen, China**  
**© 2023 BASiC Semiconductor Ltd.**  
**All Rights Reserved.**

**Information**

For further information on technology, delivery terms and conditions and prices, please contact the nearest BASiC Semiconductor Office

**Disclaimer**

The information given in this document shall in no event be regarded as a guarantee of conditions or characteristics. With respect to any examples or hints given herein, any typical values stated herein and/or any information regarding the application of the device, BASiC semiconductor Ltd. hereby disclaims any and all warranties and liabilities of any kind, including without limitation, warranties of non-infringement of intellectual property rights of any third party.