

1206 Package Chip Infrared LED With Inner Lens IR11-21C/TR8



Features

- Small double-end package
- High reliability
- Low forward voltage
- Good spectral matching to Si photodetector
- Package in 8mm tape on 7" diameter reel
- Pb free
- The product itself will remain within RoHS compliant version.
- Compliance with EU REACH

Descriptions

IR11-21C/TR8 is an infrared emitting diode in miniature SMD package which is molded in a water clear plastic With flat top view lens.

The device is spectrally matched with silicon photodiode and phototransistor.

Applications

- PCB mounted infrared sensor
- Infrared emitting for miniature light barrier
- Floppy disk drive
- Optoelectronic switch
- Smoke detector

Device Selection Guide

Part Category	Chip Material	Resin Color
IR	GaAlAs	Water Clear

Package Dimensions

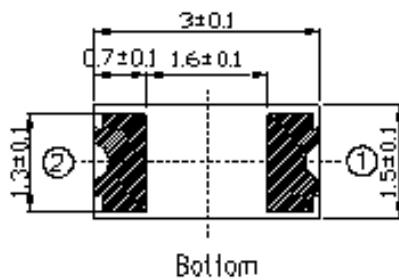
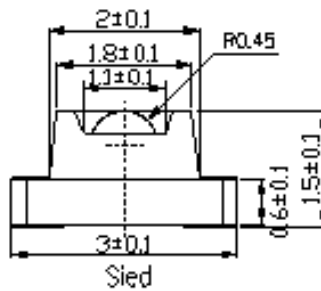
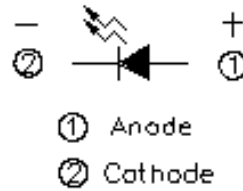
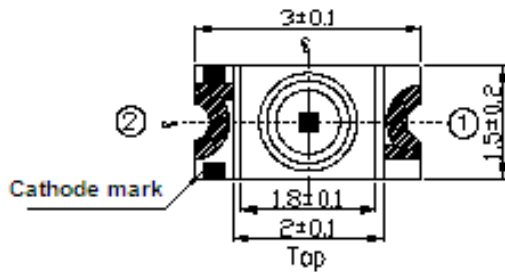

Recommend soldering pad

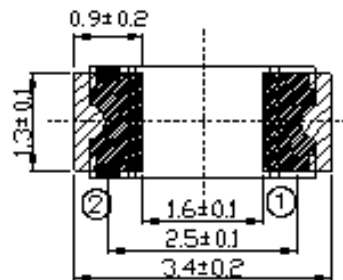

- Notes:**
1. All dimensions are in millimeters
 2. Tolerances unless dimensions ± 0.1 mm
 3. Suggested pad dimension is just for reference only
Please modify the pad dimension based on individual need

Absolute Maximum Ratings (Ta=25)

Parameter	Symbol	Rating	Units
Continuous Forward Current	I_F	65	mA
Reverse Voltage	V_R	5	V
Operating Temperature	T_{opr}	-25 ~ +85	
Storage Temperature	T_{stg}	-40 ~ +85	
Soldering Temperature *1	T_{sol}	260	
Power Dissipation at(or below) 25 Free Air Temperature	P_d	130	mW

Notes: *1.Soldering time 5 seconds.

Electro-Optical Characteristics (Ta=25)

Parameter	Symbol	Condition	Min.	Typ.	Max.	Units
Radiant Intensity	I_e	$I_F=20mA$	0.5	1.6	--	mW /sr
Peak Wavelength	λ_p	$I_F=20mA$	--	940	--	nm
Spectral Bandwidth	$\Delta\lambda$	$I_F=20mA$	--	45	--	nm
Forward Voltage	V_F	$I_F=20mA$	--	1.2	1.5	V
Reverse Current	I_R	$V_R=5V$	--	--	10	μA
View Angle	$2\theta_{1/2}$	$I_F=20mA$	--	100	--	deg

Typical Electro-Optical Characteristics Curves

Fig.1 Forward Current vs. Ambient Temperature

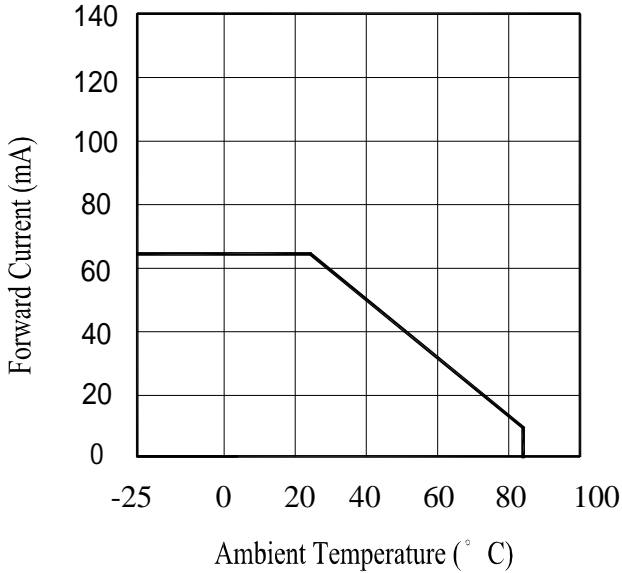

Fig.2 Spectral Distribution

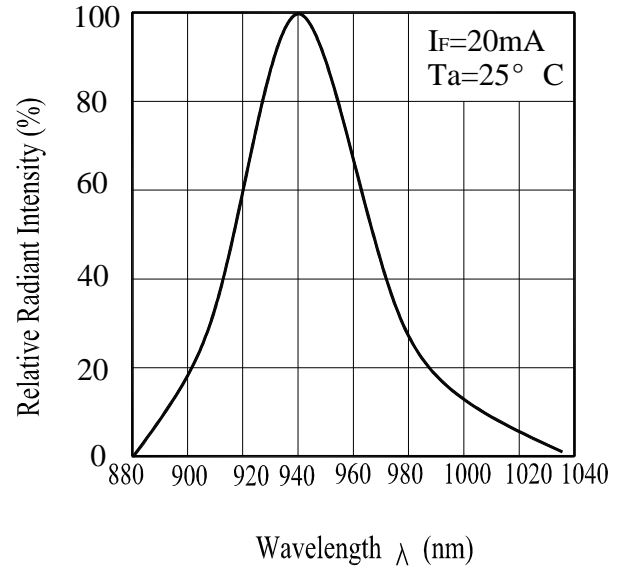

Fig.3 Forward Current vs. Forward Voltage

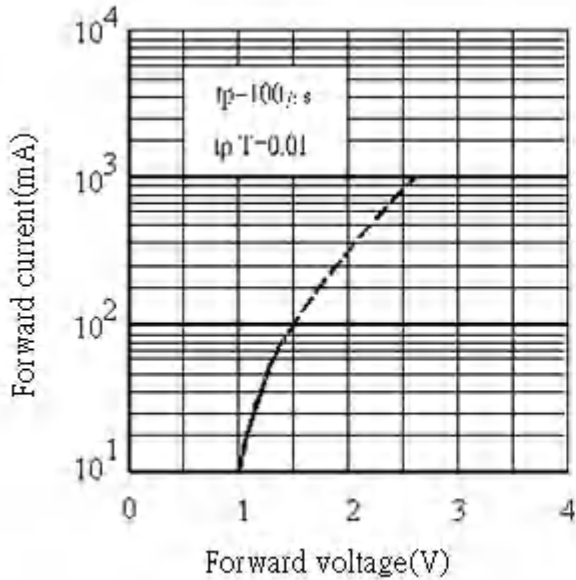
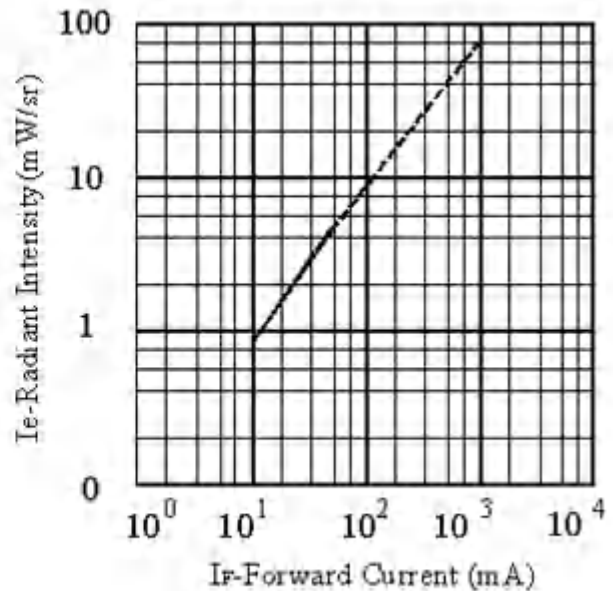
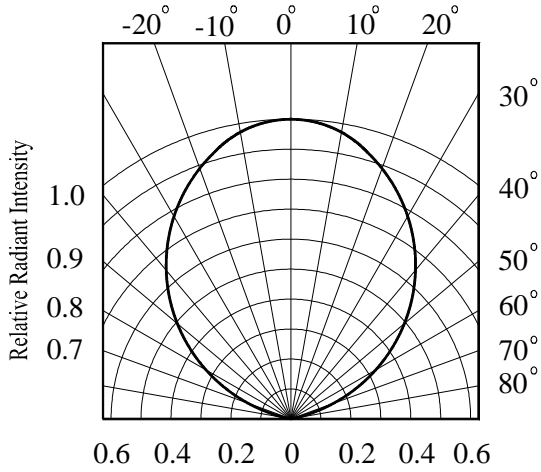

Fig.4 Relative Intensity vs. Forward Current



Typical Electro-Optical Characteristics Curves

Fig.5 Relative Radiant Intensity vs.
Angular Displacement



EVERLIGHT

Precautions For Use

1. Over-current-proof

Customer must apply resistors for protection, otherwise slight voltage shift will cause big current change (Burn out will happen).

2. Storage

2.1 Do not open moisture proof bag before the products are ready to use.

2.2 Before opening the package, the Photodiode should be kept at 10 ~30 and 90%RH or less.

2.3 The Photodiode suggested be used within one year.

2.4 After opening the package, the devices must be stored at 10°C~30°C and ≤ 60%RH, and used within 168 hours (floor life). If unused Photodiode remain, it should be stored in moisture proof packages.

2.5 If the moisture absorbent material (desiccant material) has faded or unopened bag has exceeded the shelf life or devices (out of bag) have exceeded the floor life, baking treatment is required.

2.6 If baking is required, refer to IPC/JEDEC J-STD-033 for bake procedure or recommend the following conditions:

96 hours at 60°C ± 5°C and < 5 % RH (reeled/tubed/loose units)

3. Soldering Condition

3.1 Lead solder temperature profile

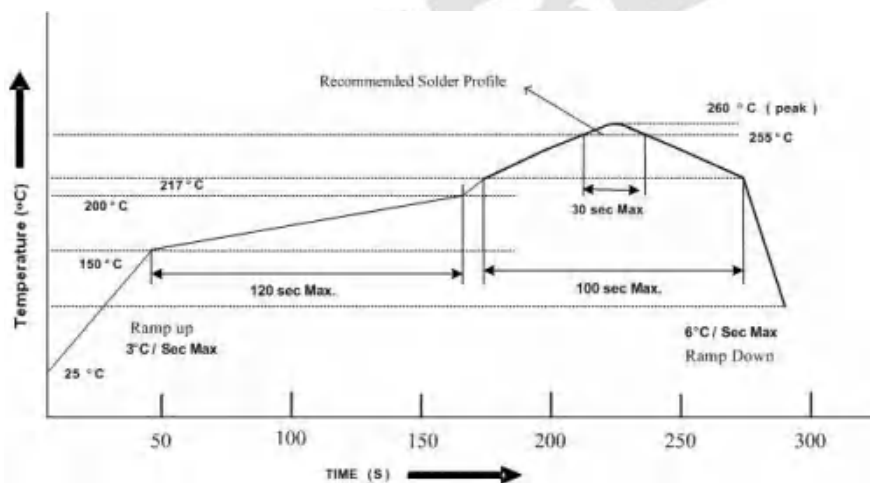

3.2 Reflow soldering should not be done more than two times.

3.3 When soldering, do not put stress on the LEDs during heating.

3.4 After soldering, do not warp the circuit board.

4.Soldering Iron

Each terminal is to go to the tip of soldering iron temperature less than 350 for 3 seconds within once in less than the soldering iron capacity 25W. Leave two seconds and more intervals, and do soldering of each terminal. Be careful because the damage of the product is often started at the time of the hand solder.

5.Repairing

Repair should not be done after the LEDs have been soldered. When repairing is unavoidable, a double-head soldering iron should be used (as below figure). It should be confirmed beforehand whether the characteristics of the LEDs will or will not be damaged by repairing.

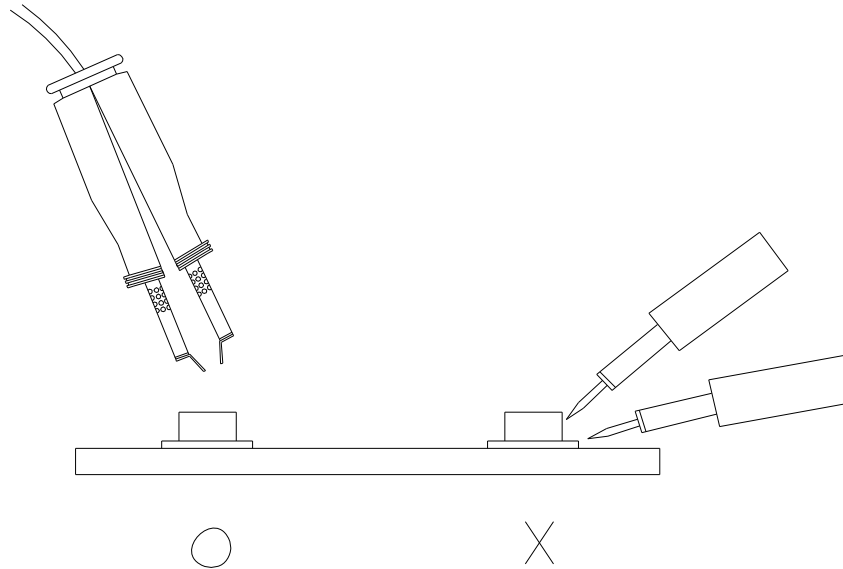

Package Dimensions

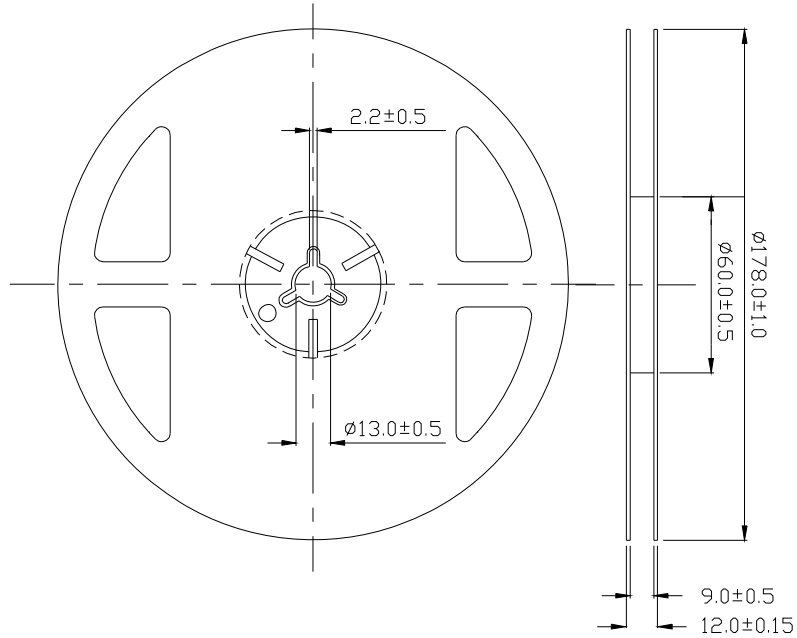

Note: The tolerances unless mentioned are ± 0.1 mm, Unit: mm

Carrier Tape Dimensions: (Loaded Quantity: 2000pcs/reel)

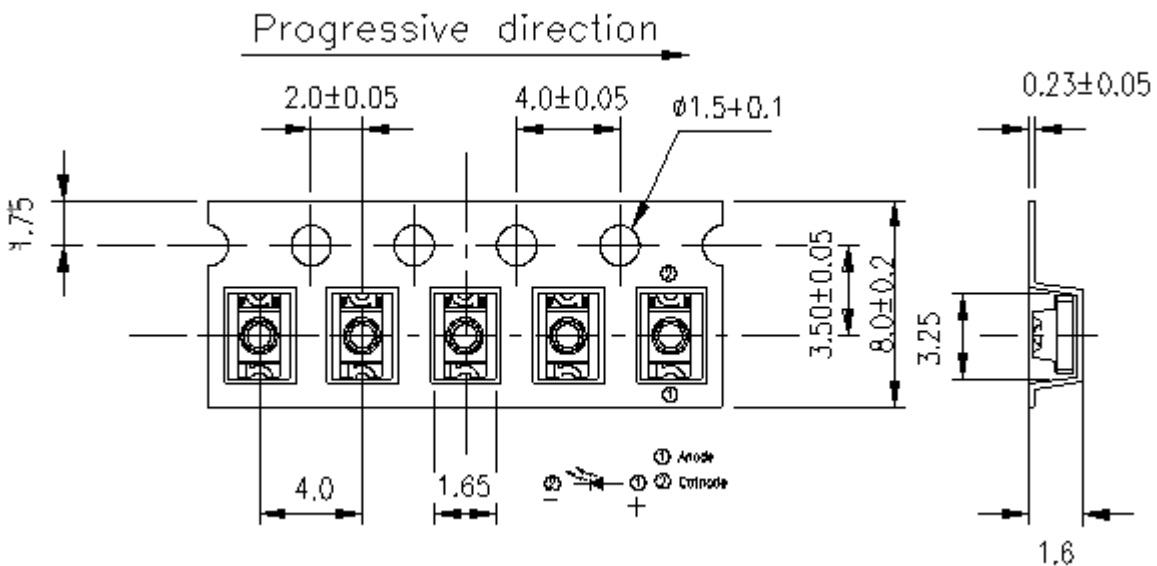

Note: The tolerances unless mentioned is ± 0.1 mm, Unit = mm

